



# Historic Yonge Street Heritage Conservation District Plan

January, 2016

For City of Toronto  
Heritage Preservation Services

Prepared by DIALOG,  
in association with Philip Goldsmith, Carl Bray,  
and Archaeological Services Inc.

This HCD Plan was prepared by DIALOG in association with Philip Goldsmith, Archaeological Services Inc., and Carl Bray, for Heritage Preservation Services at the City of Toronto.

**DIALOG**<sup>®</sup>

In Partnership with:

Philip Goldsmith

Carl Bray



Archaeological Services Inc.



#### Maps

The maps presented in this plan, although reasonable accurate, are intended for illustrative purposes. Maps which require precise boundaries, such the HCD boundary, will be provided by the City of Toronto as an attachment to the by-law adopting this HCD Plan.



# ACKNOWLEDGMENTS

The Historic Yonge Street area was nominated to be studied as a potential Heritage Conservation District (HCD) by the Bay Cloverhill Community Association and the Church Wellesley Neighbourhood Association. The formal HCD Study & Plan process leading to this report was initiated by the City of Toronto's Heritage Preservation Services. Throughout the HCD Study & Plan process, community members provided input and comments. These contributions were important to capturing the character of Historic Yonge Street. A number of volunteers became further involved by assisting with the built form and landscape survey required as part of the HCD Study. We are extremely grateful for this participation. In addition, we would also like to thank the other community representatives who provided their contribution through public meetings and stakeholder interviews, which include: City Park Co-op, The Greater Yorkville Residents' Association, Canadian Lesbian and Gay Archives, Downtown Yonge BIA, Church Wellesley BIA, Bloor Yorkville BIA, Buddies in Bad Times Theatre, Panasonic Theatre, Cat's Cradle Boutique, Northbound Leather, Morningstar Trading, Heritage Toronto, The Architectural Conservancy of Ontario, and The Toronto Historical Association.

**Thank you!**

# CONTENTS

ACKNOWLEDGMENTS.....	III
PREFACE & READER'S GUIDE .....	VI
<b>1.0 INTRODUCTION .....</b>	<b>1</b>
1.1 HCD PROJECT OVERVIEW .....	1
1.2 HCD PLAN PROCESS.....	3
<b>2.0 POLICY &amp; LEGISLATIVE FRAMEWORK.....</b>	<b>5</b>
2.1 HERITAGE AND PLANNING POLICY .....	5
<b>3.0 DISTRICT SIGNIFICANCE.....</b>	<b>9</b>
3.1 STATEMENT OF CULTURAL HERITAGE VALUE .....	9
3.2 DISTRICT HERITAGE ATTRIBUTES.....	10
3.3 CONSERVATION OBJECTIVES.....	12
<b>4.0 DISTRICT BOUNDARY &amp; RESOURCES .....</b>	<b>13</b>
4.1 DISTRICT BOUNDARY .....	13
4.2 CONTRIBUTING & NON-CONTRIBUTING RESOURCES.....	14
4.3 ARCHAEOLOGY .....	16
4.4 CHARACTER AREAS .....	17
<b>5.0 POLICIES &amp; GUIDELINES FOR CONTRIBUTING PROPERTIES .....</b>	<b>19</b>
5.1 UNDERSTANDING.....	20
5.2 EXISTING PART IV DESIGNATIONS.....	21
5.3 DEMOLITION & REMOVAL .....	22
5.4 MAINTENANCE.....	23
5.5 RESTORATION.....	23
5.6 ALTERATIONS & REPAIR.....	24
5.7 ADDITIONS.....	24
5.8 MASSING.....	25
5.9 STOREFRONTS .....	27
5.10 FAÇADE PATTERNS AND FEATURES.....	28
5.11 WINDOWS & FENESTRATION.....	29
5.12 AWNINGS.....	30
5.13 ROOFS.....	31
5.14 MATERIALITY & WALL DESIGN .....	33
5.15 SIGNAGE.....	35
5.16 VIEWS & KEY VIEW SITES.....	37
5.17 CODE COMPLIANCE AND ACCESSIBILITY.....	38
5.18 SUSTAINABILITY.....	39
5.19 OVER-CLAD BUILDINGS.....	39

<b>6.0</b>	<b>POLICIES &amp; GUIDELINES FOR</b>		<b>8.0</b>	<b>ARCHAEOLOGY .....</b>	<b>57</b>
	<b>NON- CONTRIBUTING PROPERTIES .....</b>	<b>41</b>	8.1	POLICY CONTEXT .....	57
6.1	UNDERSTANDING.....	42	8.2	ARCHAEOLOGICAL RESOURCE	
6.2	DEMOLITION.....	42		REQUIREMENTS.....	59
6.3	ADDITIONS AND ALTERATIONS.....	43	<b>9.0</b>	<b>IMPLEMENTATION &amp; ADMINISTRATION OF</b>	
6.4	MASSING.....	43		<b>THE HCD PLAN .....</b>	<b>61</b>
6.5	FAÇADE PATTERNS AND FEATURES.....	45	9.1	MINOR ALTERATIONS NOT	
6.6	WINDOWS & FENESTRATION .....	47		REQUIRING A PERMIT.....	61
6.8	MATERIALITY & WALL DESIGN .....	48	9.2	HCD ADMINISTRATION, INCENTIVES	
6.9	VIEW CORRIDORS & LANDMARKS .....	49		& PROCEDURES.....	62
6.10	SIGNAGE.....	50	9.3	ADDITIONAL RECOMMENDATIONS.....	64
6.11	POLICIES FOR ADJACENT PROPERTIES .....	50		<b>BIBLIOGRAPHY.....</b>	<b>65</b>
<b>7.0</b>	<b>POLICIES &amp; GUIDELINES FOR</b>		<b>A</b>	<b>APPENDIX A: DEFINITIONS.....</b>	<b>67</b>
	<b>LANDSCAPES .....</b>	<b>51</b>	<b>B</b>	<b>APPENDIX B: SCHEDULE OF</b>	
7.1	LANEWAYS.....	52		<b>CONTRIBUTING PROPERTIES .....</b>	<b>71</b>
7.2	STREET TREES.....	53	<b>C</b>	<b>APPENDIX C: SCHEDULE OF</b>	
7.3	PARKING.....	53		<b>NON-CONTRIBUTING PROPERTIES.....</b>	<b>109</b>
7.4	PRIVATELY OWNED		<b>D</b>	<b>APPENDIX D: HCD STUDY - HISTORY</b>	
	PUBLICLY-ACCESSIBLE SPACE (POPS).....	54		<b>AND EVOLUTION OF THE STUDY AREA.....</b>	<b>111</b>
7.5	UTILITIES AND PUBLIC WORKS .....	54	<b>E</b>	<b>APPENDIX E: HCD STUDY -</b>	
7.6	LIGHTING & STREET FURNISHINGS.....	55		<b>CHARACTER ANALYSIS.....</b>	<b>127</b>
7.7	CIRCULATION.....	56			



## Preface

Yonge Street is one of Canada's great streets. Over the past 225 years of its history, Yonge Street has played a vital role as a key regional route for settlement, commerce and travel, as a locally important commercial Main Street for adjacent residential areas, and as a national magnet and hub of artistic and cultural activity. Some of Toronto's most storied moments have happened on Yonge Street and today the area is still regarded as the street of choice for Toronto's parades, demonstrations and spontaneous celebrations.

The section of Yonge Street between College Street and Bloor Street shares the route's dynamic history but has generally been occupied by independent businesses, government services, professional and fraternal organizations and cultural/entertainment venues. Over the past few years, Yonge Street's

*"Urban heritage is of vital importance for our cities – now and in the future. Tangible and intangible urban heritage are sources of social cohesion, factors of diversity and drivers of creativity, innovation and urban regeneration – we must do more to harness this power."*

*- Irina Bokova, Director-General of UNESCO as the World Urban Forum (Naples, 2012)*

desirability as a destination address has attracted interest and investment in other kinds of development along the corridor. As Toronto continues to grow and evolve, it is imperative that the City bring forward policies that retain what has made Yonge Street historically great into the future.

A Heritage Conservation District (HCD) is a planning tool that municipalities can use to manage and guide change in historically important areas. HCDs are designated under Part V of the Ontario Heritage Act and an HCD Plan contains policies and guidelines that are designed to conserve the district's unique cultural heritage values and resources. HCD plans are created based on a thorough understanding of the district's history, its significance, its heritage character and the attributes that collectively express that character.

# PREFACE & READER'S GUIDE

While an HCD Plan provides a planning framework for managing change, it can also serve as a common reference point for community members, property owners, developers, entrepreneurs, elected representatives and City staff. In this way, heritage conservation can act as a both foundation and catalyst for sympathetic social, economic and cultural strategies; strategies that will conserve Yonge Street's existing heritage character and encourage its continued evolution and vitality.

This Plan should be read in conjunction with the City of Toronto Official Plan that gives further direction on the management and conservation of heritage resources.

*"The key to understanding and managing any historic urban environment is the recognition that the city is not a static monument or group of buildings, but subject to dynamic forces in the economic, social and cultural spheres that shaped it and keep shaping it."*

*- New life for historic cities (UNESCO booklet, 2013)*

## Reader's Guide

This Plan outlines the conservation objectives for HYHCD and includes policies and guidelines to meet those objectives. It should be used to understand HYHCD's cultural heritage value, and the policies to conserve it. Property owners should consult this Plan when planning repair work, alterations, additions, or new development on their property. Community members may consult this Plan to understand the policy context that applies to HYHCD and the regulations in place to conserve its heritage resources.

The policies and guidelines are organized into four sections: Contributing Properties (section 5.0), Non-Contributing Properties (section 6.0), Landscapes (section 7.0), and Archaeology (section 8.0). Appendix B and C, respectively, include schedules of contributing and non-contributing properties that determine whether section 5.0 or 6.0 should be consulted. Depending on the type of work being considered, and the location of a property, section 7.0 and 8.0 may also apply. Note that all properties within HYHCD are designated under Part V of the *Ontario Heritage Act* and this Plan applies to all properties within its boundary.

The front end of this Plan (sections 1.0, 2.0, 3.0, 4.0) provides background information that will provide readers with an understanding of the project process, the policy context the Plan operates within, and a description of HYHCD's cultural heritage value and its conservation objectives. Section 9.0 includes information on implementing the Plan, including applying for a heritage permit and incentives for conservation.



# INTRODUCTION

## 1.1 HCD PROJECT OVERVIEW

Heritage Conservation Districts (HCDs) are designated under Part V of the *Ontario Heritage Act* for the purpose of conserving, protecting, and enhancing the integrity of resources within the HCD and the cultural heritage value they carry. An HCD provides a framework to conserve the character of a district as defined by its historical context, architecture, streets, landscape, and other physical and visual features.

Historic Yonge Street was nominated to be studied as a potential HCD by the Bay Cloverhill Community Association and the Church Wellesley Neighbourhood Association. The Historic Yonge Street HCD Study was authorized at the August 16, 2012 meeting of City Council. As part of this motion, Council also authorized the use of funds to complete the phase of work to develop plan if the study determined that designation as an HCD was appropriate. The study area was subsequently identified as a high priority HCD study area on October 2, 2012, as a result of approved prioritization criteria.

DIALOG was the lead consultant firm retained for the HCD Study and Plan. As part of the team, Philip Goldsmith, Heritage Architect, provided architectural and conservation expertise; Archaeological Services Inc. studied archaeology, history, and landscapes; and Carl Bray contributed his knowledge of heritage planning.

The HCD Study and Plan were undertaken in keeping with the City of Toronto's *Heritage Conservation Districts in Toronto: Procedure, Policies, and Terms of Reference*. That document expands upon the requirements for designating an HCD under the *Ontario Heritage Act*. It outlines detailed steps for the Study and Plan phases of an HCD designation process and informs the structure and contents of this Plan



### 1.1.1 THE HCD STUDY AREA

The area approved for study included all properties fronting onto Yonge Street between the south side of Davenport Road/Church Street and the north side of College/Carlton Street. In addition, it included predominantly residential properties in the area referred to as St. Nicholas Village, which generally lies between Wellesley Street to the south, St. Mary Street to the north, and ending at the western edge of the HCD study area.

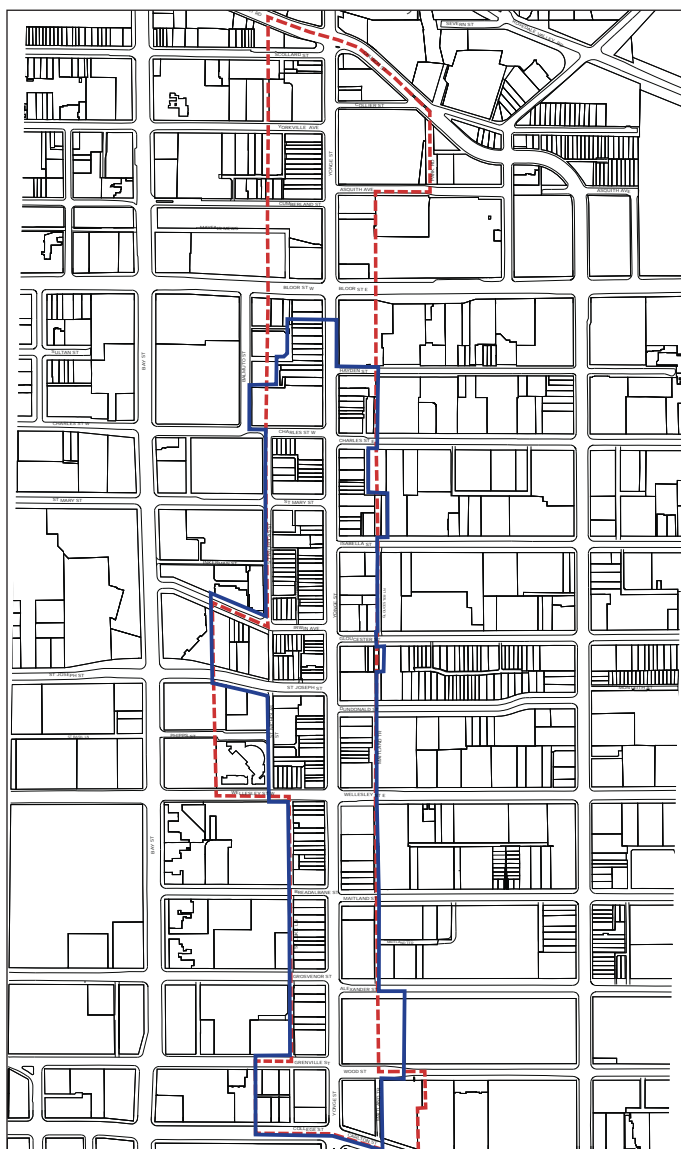

**HYHCD Boundary & Study Area Boundary.**  
■ HYHCD Boundary      ■ Study Area Boundary

### 1.1.2 HCD STUDY PROCESS

The study process consisted of three main components: researching the thematic history and evolution of the study area; surveying the built form and landscape within the study area; and, analyzing the area to identify and understand its cultural heritage value and heritage attributes.

#### Built Form & Landscape Survey

The built form and landscape survey is a requirement of the HCD Study as set out by section 40. (1) of the Ontario Heritage Act. It is a non-evaluative record used to collect information about the history and physical characteristics of the study area. The information gathered during the survey informed the analysis of the study area and its character.

Community volunteers assisted with completing the survey under the direction of the project team. All of the survey results went through an internal vetting process by the consultant team, and additional research was completed as necessary.

In total, 255 properties and 2 parks were documented and researched for a total of 257 survey forms.

#### Community Consultation

Several public engagement events were held over the course of the study. In addition to the engagement events, the consultant team presented the findings of the Study to the Toronto Preservation Board on July 28, 2015. During the meeting, several community members made verbal deputations and written submissions were also made. The Toronto Preservation Board endorsed the recommendations of the Study to proceed with an HCD Plan for Historic Yonge Street within a revised boundary.

## 1.2 HCD PLAN PROCESS

The Plan complements the existing policy framework that applies to the Historic Yonge Street Heritage Conservation District (HYHCD), while specifically addressing the conservation of its heritage attributes and cultural heritage value. The Plan aims to manage change and guiding future development in a manner that will maintain and enhance the HYHCD's character.

Developing the Plan process consisted of: refining the Statement of Cultural Heritage Value for HYHCD (section 3.0); identifying the properties that contribute to its character (section 4.0); and, preparing policies and guidelines to conserve that character.

### 1.2.1 COMMUNITY CONSULTATION

As the Plan was being prepared there were several opportunities for the general public and stakeholders to engage with the project process and understand and provide comment on the structure and substance of the Plan.

#### Public Open House

A Public Open House was held on October 14, 2015. It was advertised by way of a mail-out to all addresses within the proposed HCD boundary. Notice of the meeting was also provided

through community and ratepayers groups actively involved in the project area and process. In all, over 60 people attended. Participants were provided with an update on the structure of the Plan and its draft policy direction, and a schedule of contributing and non-contributing properties was presented for comment.



*Public Meeting #2 HCD Study Phase*



*Councillor Wong-Tam addressing participants at Public Meeting #2*

## Stakeholder Interviews

In November and December of 2015 a series of focused stakeholder interviews were completed with interested parties. This included area residents, representatives from community groups, landowners, developers, consultants working on projects in the area and business owners. During the interviews participants were given more detail about the draft policies proposed for the Plan. This was followed by a conversation about participant's interests and concerns as they relate to the Plan. The interviews were an opportunity for the project team to better understand the perspective of stakeholders, and for stakeholders to inform the policy direction of the Plan.



*Workshop session*



# POLICY & LEGISLATIVE FRAMEWORK

## 2.1 HERITAGE AND PLANNING POLICY

This section provides an overview of the legislation and policies that govern the conservation of heritage resources within Ontario and Toronto. They include, but are not limited to:

- *Ontario Heritage Act*
- *Planning Act*
- *Provincial Policy Statement*
- *Growth Plan for the Greater Golden Horseshoe*
- *City of Toronto Official Plan*
- *City of Toronto Site and Area Specific Policy 382*

This section also provides an overview, without limitation, of the land-use planning objectives of those documents that speak to both heritage conservation and land-use planning matters.

This section does not aim to be exhaustive in its summary of these documents, rather it highlights the policies and guidelines that are relevant for the Plan. The entirety of each document has also been considered.

### 2.1.1 ONTARIO HERITAGE ACT

The *Ontario Heritage Act* (OHA) is the key provincial legislation that enables municipalities to conserve, protect, and manage heritage properties and areas. Part IV enables a municipality to designate individual properties that are of cultural heritage value and Part V enables a municipality to designate groups of properties or landscapes that demonstrate cultural heritage value. Within the revised boundary for the HCD as endorsed by the Toronto Preservation Board there are 120 properties that are either listed on the City of Toronto Heritage Register or designated by the City of Toronto under Part IV of the OHA. Currently the City of Toronto has designated 21 Heritage Conservation Districts under Part V within the city as a whole.

Part V of the OHA enables a municipality to designate by by-law all, or any part of, a municipality as an HCD (section 41.(1)). The OHA enables municipalities to study an area for the purposes of designating it as an HCD (section 40.(1)). The OHA also enables a municipality to formally designate an area of the municipality as an HCD study area by by-law (section 40.1(1)). Where a by-law is passed under the OHA designating an area as an HCD, a Plan for that area is also required (section 41.1(1)).

The OHA states that where an HCD Plan is in effect, by-laws shall not be passed by the municipality for any purpose that is contrary to the objectives set out in the HCD Plan and that public works undertaken by the municipality must also not be contradictory to

the objectives of the HCD Plan (section 41.2(1)). In the event of a conflict between an HCD Plan and a municipal by-law the HCD Plan prevails to the extent of the conflict.

### 2.1.2 PLANNING ACT

The *Planning Act (Ontario)* governs land-use planning activity in Ontario. It states that the “conservation of features of significant architectural, cultural, historical, archaeological or scientific interest” is a matter of provincial interest and that the Minister, the council of a municipality, a local board, a planning board and the Ontario Municipal Board in carrying out their responsibilities under the Act shall have regard for that interest (section 2 (d)) as well as other matters of provincial interest.

Further, the *Planning Act* allows the province to issue policy statements elaborating on areas of provincial interest.

### 2.1.3 PROVINCIAL POLICY STATEMENT

The *Provincial Policy Statement (PPS, 2014)* provides direction on matters relating to municipal planning that are of provincial interest (section 3(1), *Planning Act*). It states that decisions of, amongst others, the council of a municipality, a local board, a planning board, a minister of the Crown and a ministry, board, commission or agency of the government, including the Ontario Municipal Board, in exercising any authority that affects a planning matter, shall be consistent with the policy statements in effect on the date of the decision and shall conform with provincial plans in effect on that date. The PPS is intended to be read in its entirety.

#### Cultural Heritage Landscapes

Section 2 of the PPS provides policy direction on the wise use and management of resources in the province. This includes cultural heritage and archaeology; section 2.6.1 of the PPS states that “Significant built heritage resources and significant cultural heritage landscapes shall be conserved.”

#### Archaeological Resources

The PPS also provides direction on the conservation of archaeological resources. Section 2.6.2 states that “Development and site alteration shall not be permitted on lands containing archaeological resources or areas of archaeological potential unless significant archaeological resources have been conserved.”

#### Development Adjacent to Heritage Properties

The PPS directs that planning authorities shall not permit development and site alteration on lands adjacent to heritage properties unless the proposed development and site alteration has been evaluated and it has been demonstrated that the heritage values of the adjacent heritage property will be conserved.

### 2.1.4 GROWTH PLAN FOR THE GREATER GOLDEN HORSESHOE

The *Growth Plan for the Greater Golden Horseshoe (Growth Plan, 2006)* was prepared under the *Places to Grow Act (2005)*. It is a framework for implementing the province’s vision for building stronger, prosperous communities by better growth management through to 2031. It addresses a range of issues related to transportation, infrastructure planning, land-use planning, urban form, housing, and natural heritage and resource protection. In addition, the Growth Plan identifies intensification areas and growth centres that dictate where the region’s growing population should be housed through increased population density.

According to the Growth Plan, a significant portion of population growth in the region is to be directed to already built-up areas in order to make use of existing infrastructure. The District, being within the general vicinity of downtown Toronto is part of the built-up area (policy 2.2.2.1).

Downtown Toronto is also identified as a growth centre (schedule 4). Urban growth centres are intended to receive and accommodate a significant share of population and employment growth (policy 2.2.4.4). The Growth Plan also contains gross density targets for urban growth centres (policy 2.2.2.5).

The Growth Plan also recognizes the importance of natural, built, and cultural heritage to the economic prosperity and quality of life in the province. Policy 4.2.4 contains a number of policies that direct municipalities to develop and implement policies that will encourage the conservation of natural, built, and cultural resources. Policy 4.2.4.1(e) specifically directs municipalities to develop and implement official plan policies and other strategies in support of the conservation of cultural heritage and archaeological resources where feasible, as built-up areas are intensified.

### 2.1.5 CITY OF TORONTO OFFICIAL PLAN

The *City of Toronto Official Plan* (OP) through its growth strategy and land-use designations supports and complements the PPS and the Growth Plan. It provides a comprehensive policy framework to direct and manage physical, social, and economic change. The OP encourages population and employment growth, recognizing that directing growth to appropriate areas is critical to Toronto's future. Chapter Two sets out the growth management strategy to guide re-urbanization and direct job and population growth to certain growth areas including the Downtown and Central Waterfront, the Centres, the Avenues and Employment Districts. It also indicates HYHCD is within Toronto's Downtown and that although tall buildings are permitted in downtown, they're not appropriate in all areas of downtown. The OP also sets out a policy framework that ensures the city will meet its population and employment targets by directing growth to the city's priority growth areas while still protecting the city's stable areas.

The OP (3.1.5, Heritage Conservation) outlines a general approach to conserving heritage resources in the city, as well as specific steps, such as: raising awareness of heritage conservation; providing incentives for conservation; conserving landscapes and archaeological resources; and, identifying and designating heritage conservation districts. The OP policies on conserving heritage resources were updated during the project process by Official Plan Amendment 199 which was adopted in 2013, and came into force in 2015.

As part of the general approach to heritage conservation, the OP refers to the *Standards and Guidelines for the Conservation of Historic Places in Canada* (as adopted by Council), noting that new construction and maintenance of heritage resources must be consistent with that document.

### 2.1.7 HERITAGE CONSERVATION DISTRICTS IN TORONTO: PROCEDURES, POLICIES, AND TERMS OF REFERENCE

*Heritage Conservation Districts in Toronto: Procedures, Policies and Terms of Reference* (2012) was developed by the City in order to ensure consistency in the study and planning of HCDs in Toronto. Its policies have guided the study process and preparation of this Plan, in conformity with the *Ontario Heritage Act*.

### 2.1.8 STANDARDS AND GUIDELINES FOR THE CONSERVATION OF HISTORIC PLACES IN CANADA

This Plan has been developed to apply the general methodology and conservation approach adopted by the *Standards and Guidelines for the Conservation of Historic Places in Canada*

(2010). This document was developed by Parks Canada through the Historic Places Initiative. Toronto City Council has adopted the document as a framework for conservation and the *Official Plan* requires that properties on the City's Heritage Register be conserved and maintained consistent with these Standards and Guidelines, as revised from time to time and as adopted by Council.

### 2.1.9 TALL BUILDING DESIGN GUIDELINES, 2013

The *Tall Buildings Design Guidelines* (2013) provide a vision statement for downtown tall buildings and design directives that pertain to the height, massing, typology, base and public realm interaction, and appropriate location of tall buildings. The guidelines also recognize the value of built cultural heritage resources and require that new development conserve the integrity of their cultural heritage value and attributes. Although not all properties with heritage resources can accommodate tall buildings, where appropriate, the conservation of heritage resources should inform the scale and massing of redevelopment.

Section 1.6 of the guidelines provides specific direction to tall building development in relation to heritage properties and HCDs. It requires that the three-dimensional form of a heritage resource be conserved and that the retention of façades alone is not sufficient. Further, base buildings should be designed to respect the scale and massing of adjacent built heritage resources.

### 2.1.10 NORTH DOWNTOWN YONGE URBAN DESIGN GUIDELINES, 2013

The *North Downtown Yonge Urban Design Guidelines* emerged out of the *North Downtown Yonge Planning Framework* study process. It complements the policies in SASP 382 (described in section 2.1.6).

#### Yonge Street

A large portion of the study area falls within the Yonge Street Character Area described in the guidelines. The guidelines recognize the heritage buildings along Yonge Street as important pieces of the identity of the Character Area and repeatedly note that heritage buildings and properties are to be conserved, and that any adverse impacts of new development or redevelopment will be mitigated.

The guidelines also note the importance of Yonge Street as a tourist destination and as Toronto's main street. It recognizes that Yonge Street is not just a priority retail street, but that it is a major cultural and civic corridor.

**2.1.11 ZONING BY-LAW 438-86 & 569-2013**

The harmonized zoning by-law “569-2013” has been passed by Council, and appealed to the Ontario Municipal Board. As such HYHCD is still governed under the former City of Toronto zoning by-law “438-86”. The District is generally zoned as a mixed-use area except for parts of the St. Nicholas Village Character Area which are zoned residential. A review of the existing zoning applied across HYHCD’s boundary identified three zones and a number of variations within each. There are also several properties within HYHCD that are subject to site-specific zoning.

properties, while also shaping development where growth and intensification is considered appropriate. SASP 382 provides area-wide policies to this effect, and it also provides policies specific to certain Character Areas. Portions of SASP 382 are in force, however other portions are subject to general and/or site specific appeals. Amongst other matters, the heritage related policies and certain character area related policies of SASP 382 are under appeal to the Ontario Municipal Board.

**2.1.6 CITY OF TORONTO OFFICIAL PLAN, SITE AND AREA SPECIFIC POLICY 382**

The need for *Site and Area Specific Policy 382* (SASP 382) was determined through the *North Downtown Yonge Planning Framework* (NDYPF) study process, which recognized that this study area did not have a clear and specific policy vision to address emerging issues related to increased development pressure.

SASP 382 contains policies for the NDYPF study area that are intended to provide protection for stable areas and heritage

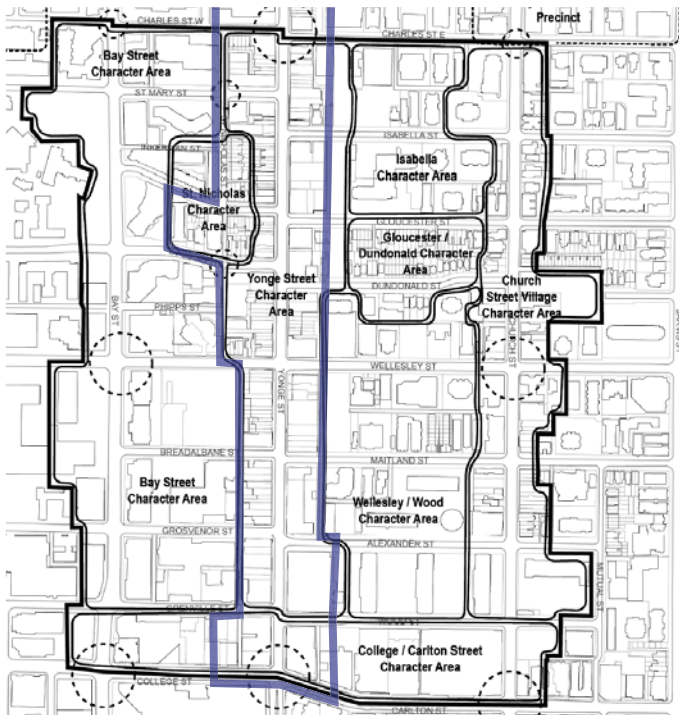

Character Area Map from SASP 382, approximate District boundary in blue



## DISTRICT SIGNIFICANCE

### 3.1 STATEMENT OF CULTURAL HERITAGE VALUE

#### Description of Historic Place

Historic Yonge Street Heritage Conservation District (HYHCD) is a distinct mixed-use neighbourhood located in downtown Toronto. It runs north-south for nine city blocks around a portion of Yonge Street and serves important civic and commercial functions in the city. It includes St. Nicholas Village, a historic residential area associated with Yonge Street, and portions of a historic network of service laneways. HYHCD contains a cohesive grouping of built heritage resources that provide a distinct sense of place and represent Toronto's early and mid-century architectural vernacular.

HYHCD's northern boundary is south of Bloor Street at 780 Yonge Street on the west side of Yonge Street, and Hayden Street on the east side of Yonge Street. College/Carlton Streets mark the southern boundary. Its western and eastern boundaries generally run parallel to Yonge Street along a historic network of service laneways, except along its western edge where it includes St. Nicholas Street and parts of St. Joseph Street and Irwin Avenue—an area referred to as St. Nicholas Village.

#### Cultural Heritage Value

HYHCD started to develop in 1860 as a pastoral landscape of large private estates that were gradually subdivided and sold-off, laying the foundation for a densely developed urban neighbourhood. Development in the area was encouraged by Yonge Street itself, which was planned as a key transportation route by Lt. Governor John Graves Simcoe.

Yonge Street's importance as a transportation route was reinforced by successive waves of transportation investment that culminated in the construction of Canada's first subway line, which opened in 1954 and runs beneath HYHCD. Public investment in transportation helped to ensure a constant flow of people through the neighbourhood, and HYHCD evolved as a commercial main street that served neighbouring residential areas and commuters who passed through it.

HYHCD is valued for its commercial main street character which is expressed, in part, by mixed-use and commercial buildings that housed the services, amenities, and employment opportunities to support daily life in neighbouring residential areas. St. Nicholas Village, and the residential buildings within it, reflects this historic relationship and reinforces HYHCD's sense of place.

Historical development of Yonge Street in the early 20th century added entertainment venues to its role as a commercial destination. The former His Majesty's Theatre at 780 Yonge Street, for instance, later became a dance studio and drama school for the emerging Canadian ballet and theatre scene, from the post-war period until the 1960s.



## 3.2 DISTRICT HERITAGE ATTRIBUTES

Once the subway opened in 1954, building technology and development patterns changed. This change is reflected in the scale of many modern buildings surrounding HYHCD. Buildings that contribute to HYHCD's character share certain characteristics in terms of their scale, height, orientation, and frontage width. They display a range of architectural styles that are appropriate to the time they were built. The historic network of laneways also contribute to HYHCD's character and are a valued element of its landscape. Together, these buildings, and the laneways that connect them, give HYHCD the feeling of being an enclave within Toronto's downtown. Approximately 90% of its buildings were built between 1860 and 1954, a period when HYHCD's commercial main street character was established and flourished.

During this period Yonge Street also developed an important civic purpose within Toronto, coming to serve as its Main Street, a role which is evidenced by the numerous parades, demonstrations, and spontaneous celebrations and gatherings that have taken place along the strip. These events, many of which are annual and ongoing, are associated with HYHCD for having passed through it. The civic importance of Yonge Street is recognized as an important component of HYHCD's character, but one that is primarily associative, and not material, in nature.

As HYHCD developed it attracted a number of important fraternal and professional organizations, including: the Masons (601-613 Yonge Street); the Oddfellows' fraternal organization (450 Yonge Street); and, the Canadian Order of Foresters (22 College Street). A number of buildings in HYHCD are also associated with important architects, including: Samuel G. Curry, Richard Ough, Mathers & Haldenby, Wickson & Gregg, George Gouinlock, Dick & Wickson, J. Gibbs Morton, and E.J. Lennox.

The cultural heritage value of HYHCD is expressed by the following heritage attributes:

- The height of buildings, which typically range between 2-4 storeys
- The three dimensional character of buildings, as articulated by their height, massing, and frontage width, which varies between character areas
- Buildings within St. Nicholas Village have small setbacks from the front lot line, creating small front yards that contribute to a more open residential character
- Buildings fronting onto Yonge Street and College/ Carlton Street are typically built to the lot line, without setbacks, which creates a consistent streetwall
- The fine grain of narrow building frontages, generally between 3-7 metres, at regular intervals along Yonge Street, and along some side streets intersecting with Yonge Street
- Frontages of larger historic buildings that are divided into bays, maintaining the rhythm of narrow storefronts and giving the appearance of more buildings
- Recessed entrance doorways, which in some cases include flanking showcase windows
- Building façades that are generally constructed with brick, stone, and wood detailing
- Building façades that display a variety of architectural details and features including, but not limited to cornices, entablatures, pilasters, soffits, punched windows, and their surrounds
- High-quality design and craftsmanship exhibited in contributing resources
- The higher percentage of glazing on ground floor façades along Yonge Street, relative to upper floors, that demarcates a retail use at-grade and residential and/or commercial uses in upper floors

- The consistent percentage of glazing between ground and upper floors on residential buildings, showing a consistent use and function between ground and upper floors
- Mixed-use and commercial buildings that typically have flat roofs, or roofs sloped towards the street that the building fronts onto
- House-form buildings typically have sloped roofs, which includes a combination of roofs sloped towards the street, and roofs sloped parallel to the street in the case of a dormer or central gable
- House-form buildings that display a range of architectural styles, most commonly: Gothic Revival, Second Empire, and Queen Anne
- Apartment-form buildings within St. Nicholas Village that display Art Deco and Edwardian Architectural styles
- Mixed-use and commercial buildings that display a range of architectural styles, most commonly: Georgian, Italianate, Romanesque, and Second Empire
- Warehouses and commercial buildings fronting onto service laneways and side streets, such as those along St. Nicholas Street and Gloucester Lane
- Views toward prominent buildings, such as the Firehall Clock Tower (484 Yonge Street), the Mason's Hall (601-613 Yonge Street), Postal Station F (675 Yonge Street), Oddfellows Hall (450 Yonge Street), and College Park (444 Yonge Street)
- Narrow public laneways that support commercial operations along Yonge Street, and are used by pedestrians as a circulation network

### 3.3 CONSERVATION OBJECTIVES

The overall objective of this Plan is to conserve, maintain, and enhance the cultural heritage value and heritage attributes of HYHCD in order to preserve these qualities for the benefit of current and future generations. The overall objectives of this Plan focuses on conserving the physical character and the function of the Historic Yonge Street HCD.

The following objectives have been developed such that the cultural heritage value and heritage attributes identified in the Statement of Cultural Heritage Value are conserved. These objectives will be the foundation for policies governing heritage conservation measures within HYHCD's boundary. Although the following objectives are numbered, this does not indicate, nor should it be taken to imply, a hierarchy of importance.

1. Conserve, maintain, and enhance the heritage character of HYHCD as expressed through its heritage attributes and cultural heritage value.
2. Ensure that new development conserves the heritage character of HYHCD and maintains and enhances its cultural heritage value and does not detract from it.
3. Maintain and enhance the heritage attributes of those resources that contribute to the cultural heritage value of HYHCD.
4. Prevent the removal and demolition of resources, features, and attributes that contribute to HYHCD's cultural heritage value.
5. Prevent alterations that diminish HYHCD's cultural heritage value.
6. Ensure that any alteration, including adaptive reuse, is compatible with HYHCD's cultural heritage value.
7. Ensure that new development maintains and enhances HYHCD's cultural heritage value and does not detract from it.
8. Ensure infill and new development is appropriately scaled.
9. Encourage improvements to the public realm that support HYHCD's ongoing use by pedestrians as a transportation corridor so that its historic role as a commercial main street and place of congregation is reinforced.
10. Conserve the network of public laneways in HYHCD.
11. Conserve the historic main street character of HYHCD, including its streetwall, scale of buildings, and support the mixed commercial, retail, or residential uses that main street character implies.
12. Conserve the three dimensional character and form of HYHCD's built heritage resources.
13. Maintain and enhance the relationship between the main street character of Yonge Street and the residential character of St. Nicholas Village.
14. Maintain and enhance the area's role as a destination for civic assembly and use, such as for parades, demonstrations, and celebrations.

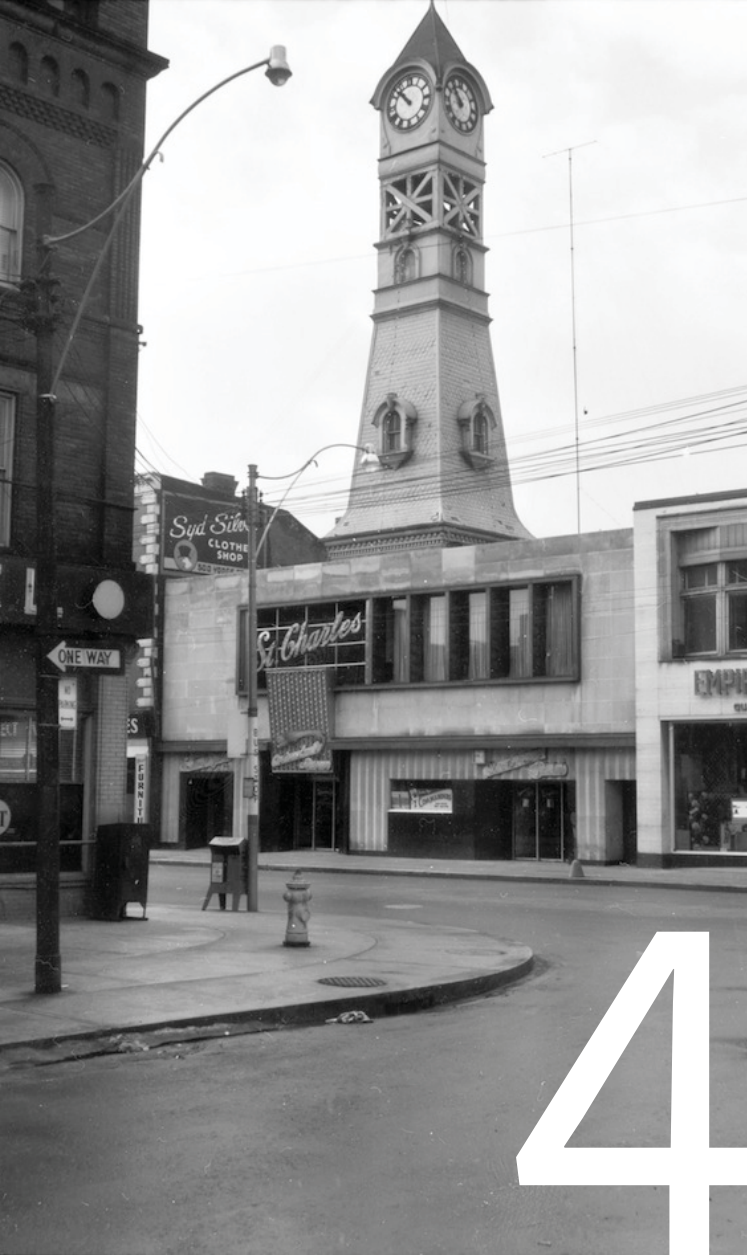

# DISTRICT BOUNDARY & RESOURCES

## 4.1 DISTRICT BOUNDARY

The delineation of HYHCD's boundary was an iterative process that evolved based on the analysis of the study area and its heritage resources. The boundary contains resources that express the heritage attributes and cultural heritage value of HYHCD.

The District boundary includes:

- Mixed-use, commercial, and residential buildings fronting along Yonge Street that support and define its main street character and sense of place
- Residential buildings fronting onto side streets that intersect with Yonge Street, and now contain retail uses that help to support the main street character of Yonge Street and illustrate HYHCD's historic development
- St. Nicholas Village because of its historical, and ongoing functional relationship to Yonge Street, and because it is a well preserved example of this relationship to Yonge Street
- Mixed-use and commercial buildings fronting onto College/Carlton Street that support the main street character of HYHCD and help to define its sense of place
- Properties on both sides of Yonge Street that define the public realm and pedestrian experience of the street

The boundary limits run along property lines and down the centre line of College/Carlton Street and Hayden Street. The full right-of-way of public laneways have been included within the boundary, as have the full right-of-way of Irwin Avenue, St. Joseph Street and Grenville Street, where the boundary does not include properties on both sides of the street.



**HYHCD Boundary**  
 HYHCD Boundary

## 4.2 CONTRIBUTING & NON-CONTRIBUTING RESOURCES

One of the key objectives of studying the resources within HYHCD is to understand which resources contribute to its cultural heritage value, and which do not. The methodology described below was used to determine contributing and non-contributing properties. The research gathered during the study phase, including the inventory of individual properties, was also referenced.

All properties within HYHCD are still designated under Part V of the Ontario Heritage Act, and managing change on both contributing and non-contributing properties is critical to conserving the cultural heritage value of HYHCD.

### Methodology

Properties were determined to be contributing if they met at least two of the following criteria:

1. The property is listed on the City's Heritage Register.
2. The property was primarily developed within the period of significance (1860-1954), or was built shortly after the period of significance and with a building height that is taller than other contributing properties, but that exhibits a mid-century modern architectural style.
3. The property demonstrates integrity of building features that are consistent with its date and style of construction, exhibits the heritage attributes of HYHCD, and is consistent with its cultural heritage value.

### Non-contributing

Properties were determined to be non-contributing if they met the following criteria:

- The property was developed outside the period of significance, or has lost the integrity of building features and architectural style.

### A Precautionary Approach

The exterior walls of several contributing properties within HYHCD have been over-clad with signage or an additional cladding material. Many of these properties otherwise satisfy the criteria described above, and have contextual value, but due to the nature of their cladding, it is difficult to determine the integrity of underlying architectural features. It is anticipated that physical investigation of the building fabric would occur when work requiring a building or heritage permit is proposed for these properties. This Plan contains policies and guidelines specific to contributing properties with this over-clad condition.

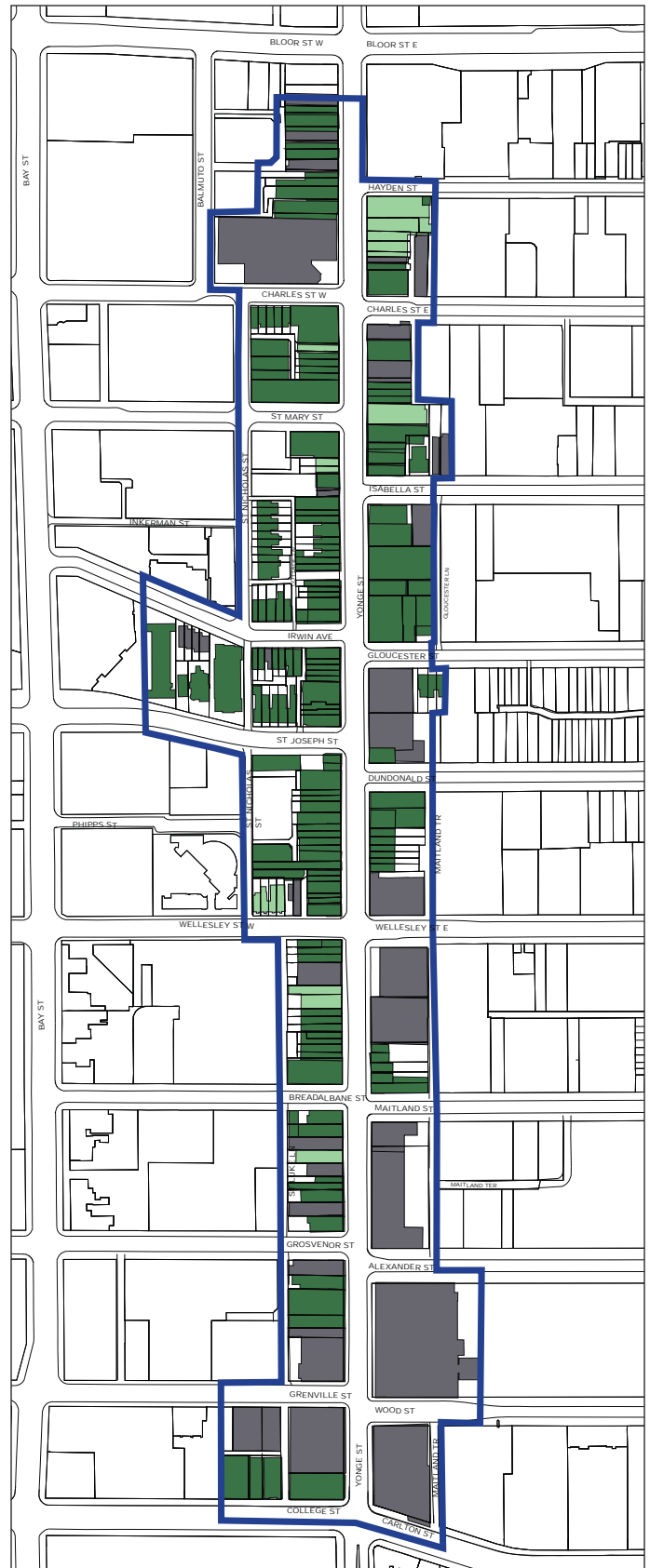

**Contributing, Non-contributing, and Over-clad Properties**

<span style="display: inline-block; width: 15px; height: 15px; background-color: #2e8b57; margin-right: 5px;"></span> Contributing Properties	<span style="display: inline-block; width: 15px; height: 15px; background-color: #90ee90; margin-right: 5px;"></span> Over-clad Properties	<span style="display: inline-block; width: 15px; height: 15px; background-color: #808080; margin-right: 5px;"></span> Non-contributing Properties
---	--	---

## 4.3 ARCHAEOLOGY

The evolution of the Historic Yonge Street HCD, including repeated episodes of construction and demolitions, the infilling of historic rear yards and open areas with new buildings, and the conversion of built up areas to open space, has left a fragmented but potentially well-preserved archaeological record. The starting point for mapping archaeological potential within HYHCD was the *City of Toronto Archaeological Management Plan*, which includes potential modelling for both pre- and post-contact archaeological resources. The Yonge Street corridor from Queen Street to Bloor Street was subject to review through examination of selected historical maps, aerial photography, and pedestrian review as part of the management plan research. For the purposes of the Heritage Conservation District Study and Plan, the area was re-examined on a property-by-property basis using a larger range of nineteenth- and twentieth-century maps to track development trends on each property and evaluate their likely effects on subsurface integrity and archaeological potential.

This process led to the identification of 18 properties in HYHCD as areas of general archaeological potential. The archaeological remains that may be present on these properties range from the buried vestiges of built features that have survived one or more redevelopment events by virtue of the massive scale at which they were constructed (in terms of the areas they covered, or the depths to which they extended) to comparatively small scale domestic deposits that have been sealed by later grade alterations. Examples of the latter include the filling that often takes place in areas given over to parking lots or other open spaces, or capping by new structures that lack substantial sub-grade structural elements.

This Plan contains policies that pertain to areas of archaeological potential.



**Areas of Archaeological Potential**

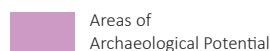

## 4.4 CHARACTER AREAS

There are distinct clusters of architectural styles, building forms, and streetscapes within HYHCD. These have been categorized as Character Areas. They help illustrate the historic evolution and development of HYHCD. Four have been identified within HYHCD:

- Historic Yonge Street Character Area
- College/Carlton Character Area
- St. Nicholas Village Character Area
- Residential Pockets Character Area

Each of these areas has certain characteristics in common with each other, including: a high proportion of buildings built before 1954; a high proportion of buildings that exhibit high-quality design and construction; the use of brick and stone masonry, carved wood, and some metal and glass in their construction; and, a physical and historical relationship to Yonge Street.

Where these areas differ is in certain aspects of their streetscape and built form, particularly between the residential (St. Nicholas Village, Residential Pockets) and mixed-use main street areas (Historic Yonge Street, College/Carlton Node).

### Historic Yonge Street Character Area

There are multiple architectural styles present in this area. The majority of buildings range in height from 2-4 storeys with a few taller buildings. 73% of the buildings in this area are representative of Edwardian, Gothic, Georgian, Italianate, Renaissance Revival, Romanesque, or Second Empire architectural styles. 89% of the buildings in this area were built before 1954 and 93% of the buildings in this area are 4 storeys or less in height.

Almost all of the buildings in this area are mixed-use with retail at grade and residential or commercial uses above.

The streetscape in this area is defined by a consistent rhythm of narrow retail frontages. These frontages are primarily glass, which adds to the animation of street life as pedestrians can view what is happening inside a shop, and customers inside a shop can see what is happening on the street. Buildings in this area are typically built to the lot line with no setbacks, which results in a consistent streetwall and contributes to a distinctive main street character on Yonge Street.

Although sidewalk widths vary throughout the area they are widest within the areas that display a main street character (Yonge Street, and College/Carlton Street). This facilitates a high degree of pedestrian traffic throughout the area.

### College/Carlton Character Area

This area shares many of the same streetscape characteristics as the Yonge Street Character Area. Where it differs is in specific aspects of its built form.

There is a distinct collection of historic commercial and institutional buildings in this area that have slightly larger floor plates and frontages than many of the buildings along Yonge Street. Several of these buildings are also Art Deco in style, and thereby establish a unique relationship with the Art Deco style building (the former Eaton's store, now College Park, a designated Part IV building) at 444 Yonge Street.

50% of the buildings in this area were built before 1954, and all of the buildings were built before 1960. Two of the taller buildings in the area are representative of Mid-Century Modern architectural styles. 55% of the buildings in this area are 4 storeys or less in height.

### St. Nicholas Village Character Area

This area is defined by its distinct stock of residential buildings including single and semi-detached houses and apartment buildings. These buildings are distinct from the mixed-use and commercial buildings in the other character areas. They do not, for example, have a higher proportion of glazing at ground floors than upper floors. The residential character of this area is reinforced by the small front-yard setbacks of buildings. Whereas buildings in the other typology areas generally have no setbacks from the front or side property line, here they do.

A majority of the buildings in this area are representative of Georgian, Gothic Revival, Queen Anne, Romanesque, or Second Empire architectural styles. Most of the buildings in this area are 4 storeys or less in height and were built before 1954.



### Residential Pockets Character Area

In several locations the commercial retail activity along Yonge Street has spilled over onto the side streets that intersect with it. Retail stores have in some cases come to occupy a building that was originally designed for residential uses. These pockets of residential buildings read similar to the buildings within St. Nicholas Village and provide a historical context to the mixed-use and commercial development along Yonge Street. Within HYHCD these resources help to illustrate its historic development.

79% of the buildings in this area are representative of Gothic Revival, Second Empire, or Romanesque Architectural styles. All of the buildings in this area were built before 1954, and are less than 4 storeys in height.

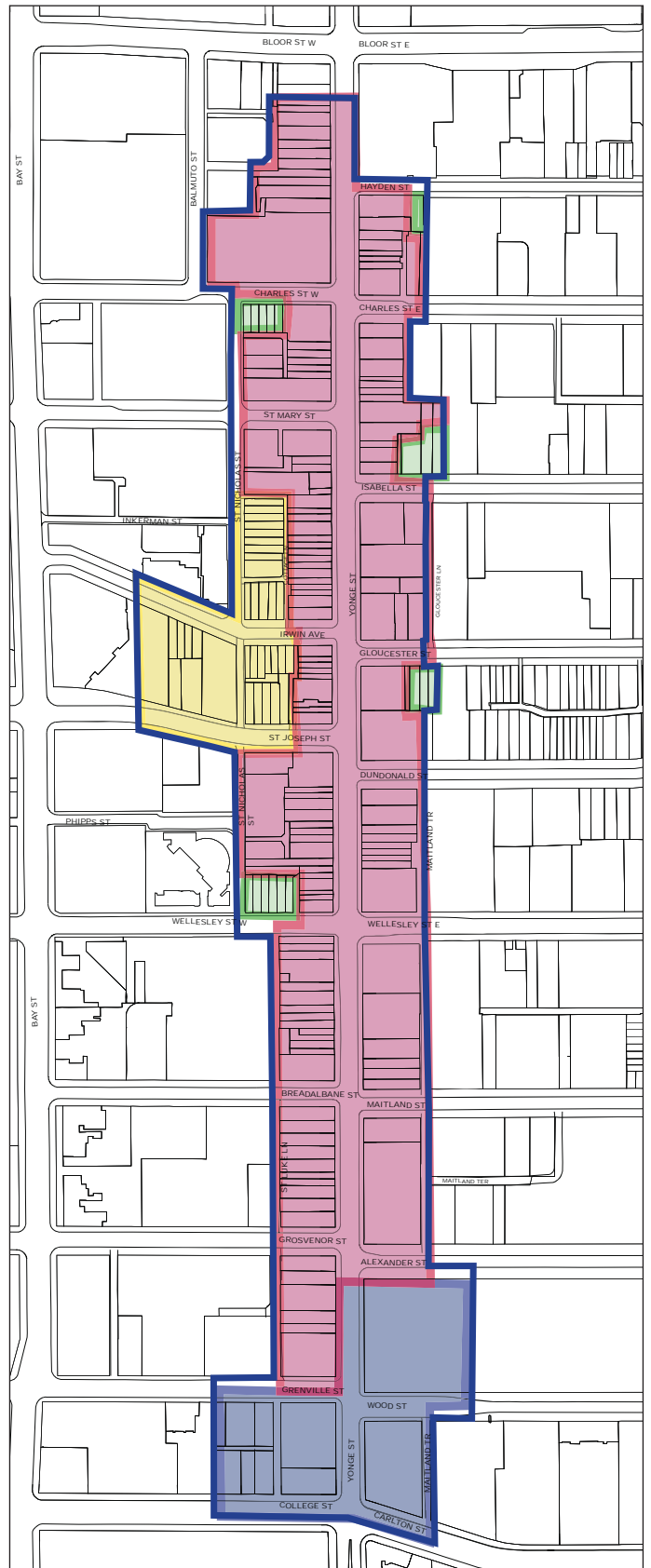

HYHCD Character Areas

- Historic Yonge Character Area
- St. Nicholas Village Character Area
- College/Carlton Character Area
- Residential Pockets Character Area



# POLICIES & GUIDELINES FOR CONTRIBUTING PROPERTIES

## Introduction

This section contains policies and guidelines for the conservation of contributing properties within HYHCD. Policies (in **bold** text) set out the general rules for conserving HYHCD's cultural heritage value, and the guidelines (presented as a bulleted list) provide specific direction on how to achieve those policies. The policies and guidelines are preceded by a short preamble that provides some background to the policy area.

In order to account for specific built form conditions within HYHCD, this section references Character Areas (described in section 4.4) identified within HYHCD:

- Historic Yonge Street Character Area
- College/Carlton Character Area
- St. Nicholas Village Character Area
- Residential Pockets Character Area

In several instances, these policies refer to the concept of designing new development to be compatible with the existing structure. Compatibility in this context includes both the physical and visual compatibility of the design. Physical compatibility refers to the use of materials and construction methods that do not have a negative impact on a contributing property, or that detracts from or damages its heritage attributes. Visual compatibility refers to designing new work in such a way that it is distinguishable from the historic building while complementing its design, massing, and proportions. Compatibility is not intended to imply historical pastiche.

Definitions have been provided for key words and included in Appendix A.

## 5.1 UNDERSTANDING

The *Standards and Guidelines for the Conservation of Historic Places in Canada* (2010) provides the basis for the conservation policies and guidelines contained in this Plan. It recommends an approach to heritage conservation that begins with understanding the heritage resource by studying its heritage attributes and the cultural heritage value they express. That understanding is the basis for the following two steps: *planning* for the conservation of the heritage resource, and *intervening* through projects and maintenance.

### 5.1.1 Additions and alterations on a contributing property will only be permitted once the cultural heritage value and heritage attributes of the property have been documented, and once the impact of the proposed alterations and/or additions have been determined and mitigated.

- This documentation and evaluation may be determined through the preparation of a Heritage Impact Assessment (HIA), as specified in the City of Toronto's HIA Terms of Reference.
- Documentary evidence of the original design and significant historical alterations or additions should include historic photos, drawings, and plans where they are available.

### 5.1.2 Prepare designs for additions and alterations based on an understanding of the heritage attributes of the property and its contribution to the cultural heritage value of HYPHD.

- To determine appropriate interventions, be consistent with historic architectural periods, the intentions and design principles of the original architect or builder, the history of a building and the changes that have been made to it over time, and the building's current conditions and contextual setting.
- Do not create a false sense of the historic evolution and development of the property by adding building features from another historic period, place, or property.

### 5.1.3 Undertake maintenance, and repair work to a contributing property based on an understanding of the property and its heritage attributes.

- Maintenance and repair work should be based on an understanding of the property and its historical evolution, and be consistent with the *Standards and Guidelines for the Conservation of Historic Places in Canada* (2010).

### 5.1.4 The design of additions, alterations, maintenance, and repair work on a contributing property and the historical research that informs them should be prepared by, or under the supervision of, a qualified heritage professional such as professional members of the Canadian Association of Heritage Professionals (CAHP).

## 5.2 EXISTING PART IV DESIGNATIONS

All properties within HYHCD are designated under Part V of the *Ontario Heritage Act*. Several properties had already been designated under Part IV of the Act, prior to the Plan being adopted by Council. Part IV designation serves a similar objective to a Part V designation, in conserving a property's heritage value. However, Part IV designation contains a more detailed description of an individual property's heritage attributes and cultural heritage value, whereas Part V designations focus on district-wide aspects.

**5.2.1** Conserve properties designated under Part IV of the *Ontario Heritage Act* based on their individual heritage attributes and statements of significance, in addition to the requirements of this Plan.

**5.2.2** In the event of a conflict between a Part IV designation and the requirements of this Plan, the conservation of heritage attributes and cultural heritage value identified in the property's Part IV designation or statement of significance will take precedence over the conservation of district-wide heritage attributes and cultural heritage value.



Part IV Designations within HYHCD

Part IV Designated Properties

## 5.3 DEMOLITION & REMOVAL

The demolition of buildings or structures on contributing properties within HYHCD is not permitted. Buildings are a primary resource and establish the character of HYHCD. Where the features of these buildings or structures have been lost a restoration approach is encouraged in keeping with the *Standards and Guidelines for the Conservation of Historic Places in Canada* (chapter 2). The demolition of remaining portions of a building after catastrophic losses may be considered after a Heritage Impact Assessment (HIA) is prepared for the property, and the City, after reviewing the HIA, is satisfied that restoration is not feasible, and that losses are not the result of neglect, deferred maintenance, or deliberate removal on the part of property owners. The City of Toronto's *Official Plan* requires submission of a satisfactory HIA for any proposed demolition of a property on the City of Toronto's Heritage register, including properties located within HCDs.

Contributing properties are protected against demolition by neglect by the City of Toronto's Property Standards By-law.

**5.3.1 The demolition or removal of buildings or structures on contributing properties is not permitted. The demolition or removal of remaining portions of a building or structure after catastrophic losses may be considered if, after reviewing a Heritage Impact Assessment, the City is satisfied that restoration is not feasible and where losses are not the result of neglect, deferred maintenance, or deliberate removal or damage. For the sake of clarity, and in accordance with the definition of "demolition" in Appendix A of this Plan, the complete disassembly of a building or structure for the purpose of reassembly at a later date will be considered demolition.**

**5.3.2 Conserve buildings or structures on contributing properties intact, in their original location, preserving relationships to adjacent buildings or structures and the street. Do not remove or relocate buildings or structures from contributing properties.**

- Buildings or structures on contributing properties should not be removed or relocated and should remain in their original location. If they are incorporated into a new addition as part of the property's redevelopment, they should remain in their original location.
- Relocation or removal of a whole building or structure remaining intact, except its sub-surface foundations, may be permitted if the relocation is a modest adjustment to an existing location and preserves the existing relationship to adjacent buildings or structures and the street, and if a study demonstrates to the satisfaction of the City that the relocation can be completed without damaging the building.
- Relocation or removal of any portion of a building or structure is considered an alteration and requires a Heritage Impact Assessment.

## 5.4 MAINTENANCE

Any maintenance work on contributing properties should be informed by an assessment and understanding of their current and historical conditions. Property owners should take a proactive approach to maintenance, which may be aided by conservation incentive programs administered by Heritage Preservation Services (see section 9.2). Standard 3, 7, 8, and 9 of the *Standards and Guidelines for the Conservation of Historic Places in Canada*, recommends an approach of minimal intervention, which is defined as addressing defects and deteriorations to ensure the long-term survival of the heritage property and the protection of its heritage values.

Article V (Heritage Property Standards) of the *City of Toronto Property Standards By-Law* (Chapter 629 of the Municipal Code) specifies minimum standards for maintenance and occupancy of Part IV and Part V designated heritage properties, as well as minimum standards for repairing or replacing heritage attributes in order to ensure that the heritage character and the visual and structural heritage integrity of the building or structure is conserved.

### 5.4.1 **Preserve and maintain contributing properties to ensure the long-term protection and conservation of the heritage attributes and cultural heritage value of HYHCD.**

- Maintain properties on an ongoing basis using recognized conservation methods in accordance with section 2 of the *Standards and Guidelines for the Conservation of Historic Places in Canada*.
- Monitor exterior walls and building features for moisture penetration and insect infestation in order to take corrective action as soon as possible.
- Maintain water shedding and diversion elements.
- Preserve and do not remove the unique patina of materials, where it exists.
- Install window cleaning systems and bird protection systems that are discrete and not visible from the public realm.
- When undertaking maintenance work, use materials and methods that will not negatively impact the existing building fabric and features.

## 5.5 RESTORATION

The restoration of a building on a contributing property may be appropriate in certain instances where its heritage attributes and building features have deteriorated beyond repair, or are missing, as established by documentary evidence. Restoration is appropriate when the historic significance of a property is clearly identifiable with a single period of that property's history, such that the removal of building features from another period and the restoration of lost heritage attributes would not negatively impact the cultural heritage value of the property. Distinguishing the historic significance of a property, its building features, and heritage attributes is important because the contributing property may have accumulated features over time that are associated with other historic periods. In some cases the building may have undergone material changes that are associated with a significant event and have come to be associated with the history and cultural heritage value of a property or district.

See section 4.3.1 and 4.3.4 of the *Standards and Guidelines for the Conservation of Historic Places in Canada* for more information.

### 5.5.1 **Restoration of a contributing property may be appropriate when the cultural heritage value of the property is linked to a clearly discernible period in its history. Plan and design restoration projects based on supporting historic documentation of the earlier forms and materials being restored.**

### 5.5.2 **When undertaking a restoration project for a contributing property, replace in-kind building features from the period to which a building is being restored that have been removed or damaged.**

- Repair rather than replace features from the period to which a building has been restored.
- Do not create a false sense of historic development by adding features from other places, properties, historic periods, or events and do not combine features that never coexisted on the property.

## 5.6 ALTERATIONS & REPAIR

Alteration refers to any intervention on a property, including repair work, that involves the material change of a building feature or element. When undertaking interventions on contributing properties, preserve historic building features rather than replacing them. Interventions on contributing properties must not detract from the property's heritage attributes or its cultural heritage value.

The approach to alterations is informed by the rehabilitation conservation treatment from the *Standards and Guidelines for the Conservation of Historic Places in Canada* (p. 16, 33-35), and the following policy together with policies under section 5.7 are based on the standards 10 for the rehabilitation of historic places. Rehabilitation involves the sensitive adaptation of a contributing property for a compatible new or continuing use, while protecting the cultural heritage value of the property. These policies therefore aim to balance new interventions on a property with maintaining and respecting its cultural heritage value. This is done by designing any proposed new work to be physically and visually compatible with the contributing property.

### 5.6.1 Preserve rather than replace the heritage attributes of the contributing property when designing and implementing alterations.

- Replace in-kind the heritage attributes or building features where the original cannot be repaired. The replaced building features should match the form, material, and detailing of the original based on existing examples or historic research.
- Where the original heritage attributes of a contributing property cannot be repaired, and where there is insufficient evidence to determine their original condition, design new building features to be compatible with the heritage attributes of the property in form, material, detailing, and style.

## 5.7 ADDITIONS

Additions refer to any new construction on a property that increases the volume of the pre-existing building on that property. This may result in an increase to the buildings gross floor area, or height, but not necessarily so.

The approach to additions as with alterations (section 5.6), is informed by standards 11 and 12 of the *Standards and Guidelines for the Conservation of Historic Places in Canada* (p. 16, 33-35). Rehabilitation involves the sensitive adaptation of a contributing property for a compatible new or continuing use, while protecting the cultural heritage value of the property. Additions must therefore be physically and visually compatible with the contributing property so as to not detract from HYHCD's heritage attributes and cultural heritage value. Likewise, additions must also conserve the historic fabric and integrity of the contributing property.

### 5.7.1 Design additions to a contributing property to conserve the heritage attributes and cultural heritage value of the property through their location, massing, height, proportions, architectural detailing, and materiality in order to be physically and visually compatible with, subordinate to, and distinguishable from the contributing property.

### 5.7.2 Minimize the loss or removal of original building material from a contributing property when designing an addition.

- Removal of original building material is strongly discouraged. Where original material must be removed, ensure the building's features and heritage attributes are not negatively impacted.
- Additions should be designed so that they may be removed or altered without negatively affecting the integrity of the contributing property.

### 5.7.3 Design additions and alterations to conserve whole or substantial portions of a contributing property in order to conserve the three-dimensional character and integrity of the property.

- Do not incorporate only façades or isolated building features into additions.
- Conserve all elements of a building that convey its height and form, including roofs and other building features.

## 5.8 MASSING

Massing refers to the location, scale, and articulation of a building's form. This includes a building's setback, the width of its façade, its height and articulation, and any stepback of upper portions of a building.

One of HYHCD's heritage attributes is a 'streetwall', which is created by contiguous buildings built to the lot line and at a relatively consistent building height. The streetwall frames the public realm and provides a distinct sense of enclosure. Vertical additions to contributing properties that conform to a streetwall condition are subject to a minimum 10 metre stepback in order to conserve the main street character of Yonge Street and the legibility of the three-dimensional quality of buildings in HYHCD.

The massing of buildings in the St. Nicholas Village Character Area and the Residential Pockets Character Area do not have a streetwall condition, however there remains a strong sense of enclosure to the public realm. Buildings in this area are set back from their front lot line, which creates a more open feel to the streetscape.

**5.8.1 Design vertical additions or alterations to a contributing property to step back a minimum of 10m from the elevation of the building on the contributing property that is fronting the street, for the entirety of the façade of the vertical addition, including any balconies.**

- Stepbacks of a minimum 10m are required from all elevation of a building on a contributing property that are adjacent to a street, including Yonge Street and all streets intersecting with it.
- Stepbacks greater than 10m may be determined where the minimum stepback does not conserve the cultural heritage value and attributes of adjacent properties.

**5.8.2 Design vertical additions or alterations to a contributing property so they do not breach a 75 degree angular plane measured at the height specified below for each Character Area and measured from each elevation of a building adjacent to and parallel with a street within HYHCD.**

- The 75 degree angular plane applies to all streets within HYHCD.
- The 75 degree angular plane will be measured from the following heights:
  - Historic Yonge Street Character Area, St. Nicholas Village Character Area, and Residential Pockets Character Area: 12 metres.
  - College/Carlton Character Area: 16 metres.

**5.8.3 Do not relocate or set back building façades on contributing properties that conform to a streetwall condition.**

**5.8.4 Design vertical additions or alterations to buildings with roofs sloped towards Yonge Street to step back a minimum of 10m from the ridge-line of the roof.**

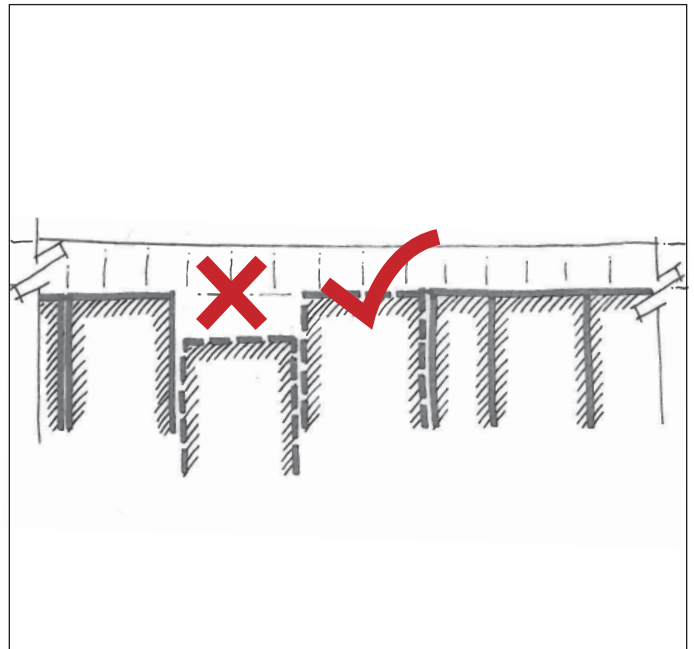

**Building Setbacks**

*Buildings on contributing properties within HYHCD should not be relocated to create new setbacks, and new development should respect the setbacks of adjacent contributing properties.*



**5.8.5 Design additions and alterations to a contributing property in the St. Nicholas Village Character Area and Residential Pockets Character Area that has a setback condition, to respect the massing and setback of the existing building.**

- Where an existing building on a contributing property is set back from the property line, locate additions and alterations to contributing properties behind extant buildings. Design the addition and alteration so that it is physically and visually compatible with, subordinate to, and distinguishable from, the contributing property.
- Do not locate additions or alterations to contributing properties in front of existing buildings on contributing properties, or in the front-yard setback of contributing properties.



**Streetwall**  
*The streetwall characteristic of HYHCD is created by adjacent properties of approximately the same height and setback.*

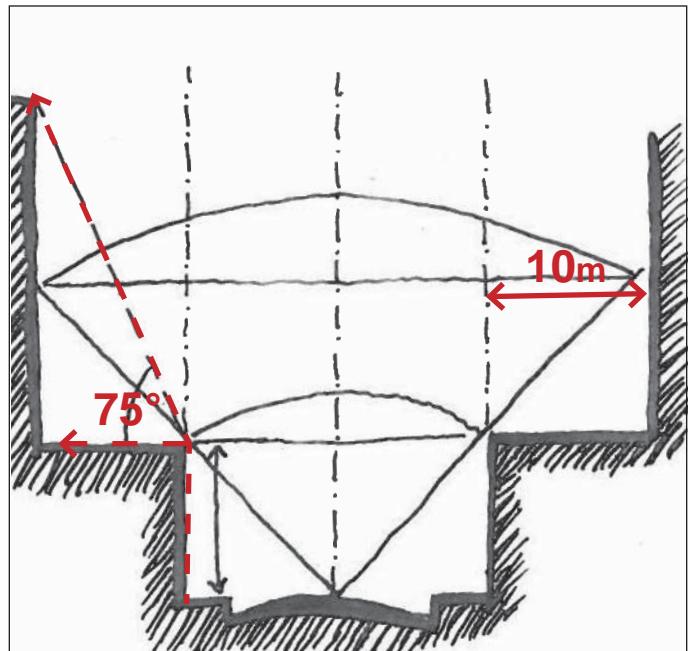

**Stepbacks and Angular Planes**  
*New development within HYHCD must conform to a 75 degree angular plane and 10m setback.*

## 5.9 STOREFRONTS

Retail and commercial activity have been important characteristics of HYHCD throughout its period of significance. This has encouraged the development of mixed-use and commercial buildings, which have distinct storefronts that have evolved over time in response to changing commercial requirements and trends.

Within HYHCD, storefronts often demarcate the division of building bays and provide a rhythm of frontages to the street.

### 5.9.1 Conserve storefronts in the design of additions and alterations to contributing properties.

- Do not alter the width of storefronts as viewed from the street, including by removing building features such as pilasters, columns, or structural walls.
- Do not alter the width of existing buildings.
- Conserve recessed shop entrances and flanking showcase windows, including any decorative material used as framing, such as carved wood or pressed metal.

- As the opportunity arises, restore decorative materials used on storefronts and storefront windows where the original material has been lost and where sufficient documentary evidence exists to support restoration.
- Commercial storefronts must not be taller than one storey at grade (approximately 4.5 metres). Double height storefronts are not permitted.
- Operable doors should be retained where they exist as a fundamental component of a storefront.

### 5.9.2 Conserve at-grade retail spaces where they have historically existed in the design of additions and alterations to contributing properties.

- Historic Yonge Street Character Area and College/Carlton Character Area:
  - Commercial retail activity that is at-grade and accessible from the public realm is an important aspect of HYHCD's character and should continue to be accommodated.

### 5.9.3 At-grade access to retail spaces and upper floors is an important aspect of the functional design of contributing commercial properties in the Historic Yonge Street Character Area. Retention of this at-grade access from Yonge Street is strongly encouraged.



#### Storefront Features

Storefronts are a varied and dynamic aspect of HYHCD's character. This diagram shows some of their more common features.

## 5.10 FAÇADE PATTERNS AND FEATURES

Elevations of contributing properties in HYHCD have well defined articulations of horizontal and vertical rhythm. These articulations often align with neighbouring structures.

The façade features that characterize the historic building stock in HYHCD include, but are not limited to: brick cladding, decorative brickwork, decorated panels, columns, pilasters, corbelling, entablatures, and stone masonry. Fenestration patterns, such as the ratio of solid to voids; the grouping of windows, the use of continuous sills, and decorated voussoirs, all contribute to the horizontal and vertical rhythm of a façade.

When determining which features should be conserved and restored, it is important to note that a property may have had features added to it at multiple intervals over its existence. Some of these features may be a better fit with a building's style than others. A Heritage Impact Assessment will be used to assess the suitability of features from differing periods for conservation and restoration.

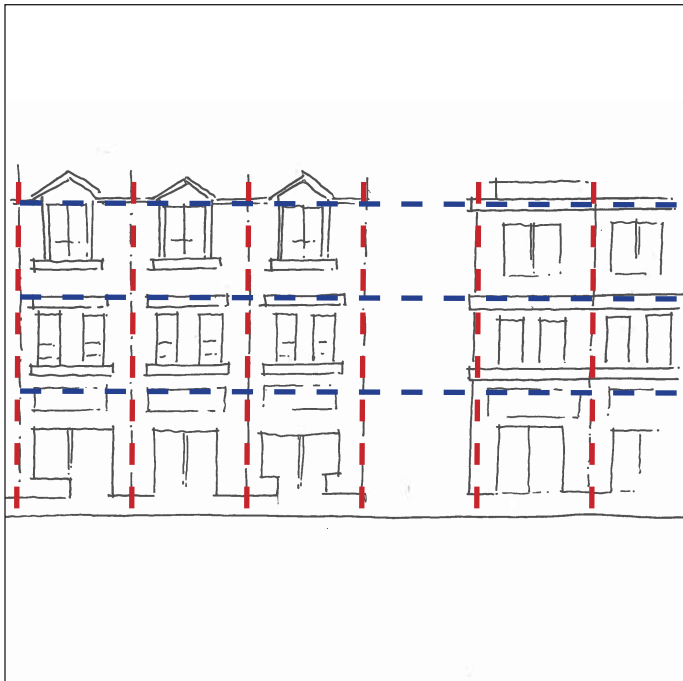

### Horizontal and Vertical Articulation

Horizontal (blue) and vertical (red) articulation patterns convey a rhythm of building façades that can inform infill and new development.

### 5.10.1 Conserve the façade features of contributing properties, including, but not limited to: pilasters, decorated panels, columns, entablatures, corbelling, and decorative brickwork.

- Any proposed work to a building on a contributing property must be informed by research and documentary evidence of the building's original façade features.
- Prioritize the preservation of original façade features that articulate a three-dimensional character.
- Façade features added to buildings on a contributing property after their date of construction should also be conserved where they contribute to the building's heritage attributes and/or HYHCD's cultural heritage value.

### 5.10.2 Do not include blank walls that face public streets or public open spaces on new additions to contributing properties.

- Walls that face the public realm at grade should include windows and doors, as appropriate.

## 5.11 WINDOWS & FENESTRATION

Windows, window openings, and their features are prominent elements of a building's character and help to illustrate the horizontal and vertical rhythm of building façades. Contributing properties within HYHCD are characterized by vertically-oriented window openings. Some historic windows have been replaced with single sash glazing, but some historic windows remain.

Features of windows and window openings include, but are not limited to: lintels, voussoirs, keystones, pediments, decorative sides, sills, transoms, window sashes, muntins, and the materials used to construct these features.

See section 4.3.5 and 4.5.6 of the *Standards and Guidelines for the Conservation of Historic Places in Canada* for more detail.

### 5.11.1 Conserve solid to void ratios in the design of additions to contributing properties.

- Additions to contributing properties that are not stepped back from a building face or lot line must maintain the solid-to-void ratios of the contributing property.

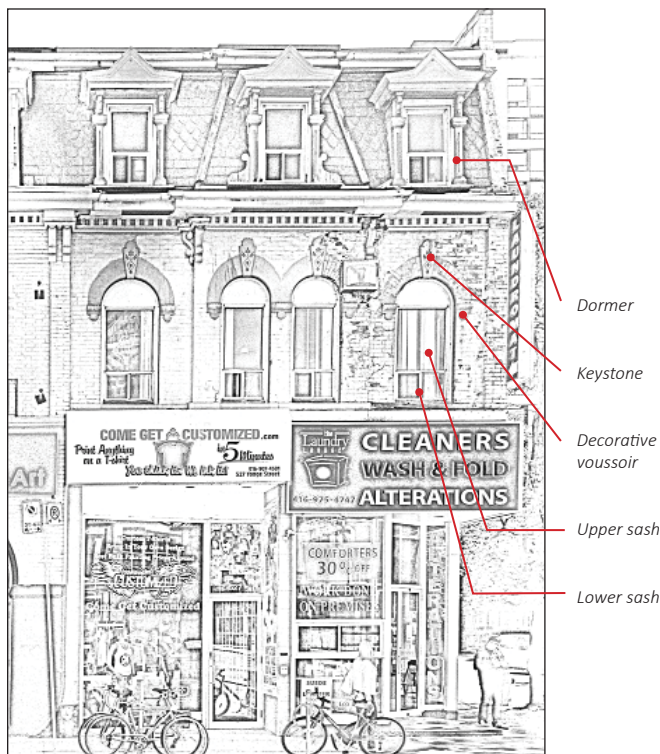

#### Window Features

This diagram shows common features of windows and window openings.

### 5.11.2 Design alterations to contributing properties to conserve historic windows and window openings.

- Do not remove or block historic window openings.

### 5.11.3 Conserve features of historic windows in the design of additions and alterations to contributing properties.

- Repair rather than replace damaged or deteriorated features of historic windows and window openings.
- Conserve original muntin and sash profile and dimensions.
- Conserve historically operable windows where they exist.
- When retro-fitting for double glazed windows, design new windows to closely match original window assemblies, including muntin and glazing configuration.

### 5.11.4 As the opportunity arises, restore historic window openings of contributing properties where they have been lost based on historic research and documentation.

### 5.11.5 When the replacement of historic windows on a contributing property is necessary, replacements must be in-kind, maintaining the form, appearance, materials, functionality, glazing patterns, and details of the original windows.

- Only replace window features that are irreparably damaged, rather than replacing an entire window unit.

### 5.11.6 When the replacement of non-historic windows on a contributing property is necessary, design replacements to be physically and visually compatible with the building.

- When assessing the compatibility of replacement windows, consider the form, appearance, materials, functionality, glazing patterns, and detailing of the new window.
- Non-historic windows must be replaced with historically appropriate windows where there is sufficient documentary evidence to support this work. Any remaining historic windows should strongly inform the design and configuration of replacement windows.

## 5.12 AWNINGS

Awnings have been used in HYHCD, and have continued to be used for shading at windows and storefronts.

**5.12.1 Awnings may be installed on a building on a contributing property only where they were originally part of the building's design, and where they can be designed in keeping with the original awning style. Design awnings to be physically and visually compatible with the contributing property, as exemplified by its architectural style, materials, and rhythm of bays.**

- Window awnings should span the full width of the window opening.
- Where appropriate, install storefront awnings within the primary structure of the storefront, respecting the rhythm of retail bays.



### **Storefront and Window Awnings**

*This photograph shows how awnings have historically been incorporated into a building's design. Storefront awnings span the width of the store, and window awnings span the window opening.*

## 5.13 ROOFS

The roofs of contributing properties are important components of their character and are occasionally detailed with distinctive features that contribute to HYHCD's cultural heritage value. In the context of this document, 'roof' refers to the entire three dimensional structure and design of a building's roof. Roofing materials are an element of roof design, and may be an important feature of a contributing property when visible from the public realm.

Roof features include, but are not limited to: their three-dimensional massing and profile, as well as cornices, brackets, fascia, soffits, mansard roofs, dormers, parapets, tower features, and roofing materials.

See section 4.3.3 of the *Standards and Guidelines for the Conservation of Historic Places in Canada* for more detail.

### 5.13.1 Conserve the profile and design of historic roofs when designing additions and alterations to contributing properties.

- Design the massing and location of vertical additions to conserve the historic roof profile and design, as viewed from the street.

- Locate new rooftop elements including but not limited to mechanical penthouses, drainage components, solar panels, satellite dishes, skylights, and new chimneys so they do not breach a 30 degree angular plane measured from the parapet of the building on a contributing property.
- Use screening or other methods to reduce impact of rooftop elements on HYHCD's cultural heritage value.
- Decks on roofs and their guardrails should not be visible from the street.

### 5.13.2 Conserve historic roof features in the design of additions and alterations to contributing properties.

- Do not remove historic roof features.
- Repair rather than replace historic roof features.
- Restore only historic roof features that have deteriorated beyond repair, rather than replacing an entire roof.
- Design eaves-troughs and downspouts so that their form, material, and colour do not detract from HYHCD's heritage attributes or cultural heritage value.

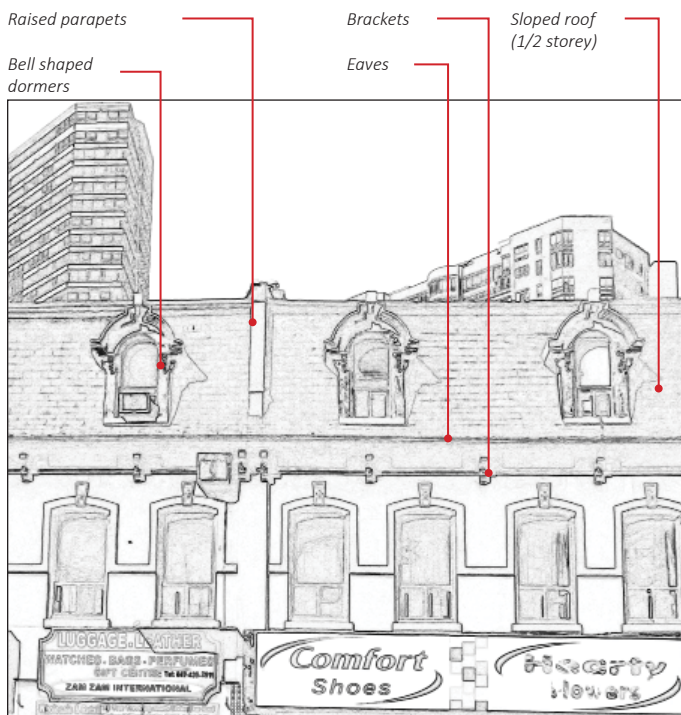

Mansard

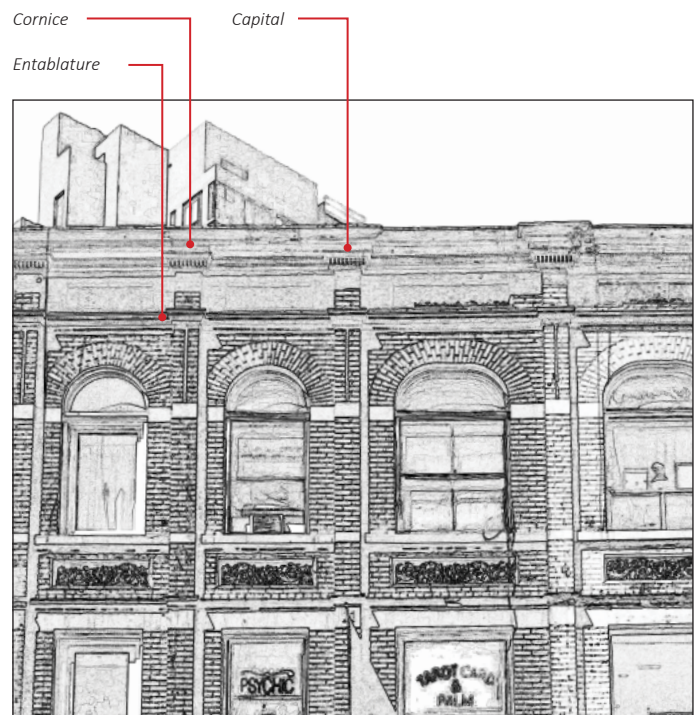

Flat with Cornice

**5.13.3 Restore historic roof features of contributing properties where they have been lost, as the opportunity arises.**

- Restore historic roof features based on documentary evidence of the roof's historic condition.
- Roofing materials should be restored based on documentary evidence.

**5.13.4 When the replacement of a historic roof or roof feature on a contributing property is necessary, replacements must be in-kind, conserving the historic form, appearance, materials, and features of the roof.**

**5.13.5 When the replacement of a non-historic roof, or roof feature, on a contributing property is necessary, restoration of the original roof or roof feature based on documentary evidence is strongly encouraged.**

- A replacement roof must be physically and visually compatible with the building, in terms of its form, appearance, materials, and features.
- In assessing the compatibility of a replacement roof or roof feature, the form, materials, profile, features, and design of the replacement will be considered.



Gable

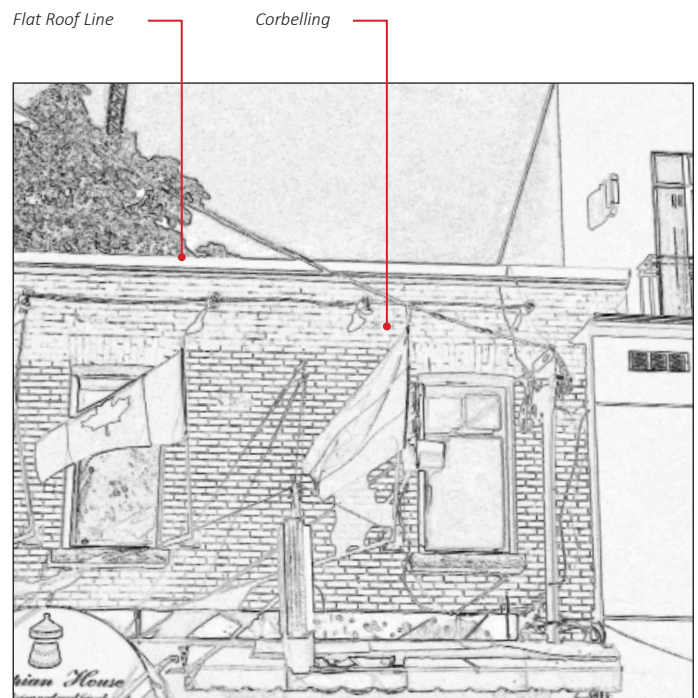

Flat

## 5.14 MATERIALITY & WALL DESIGN

The exterior walls of contributing properties that face the public realm are important features that contribute to HYHCD's heritage character. Interventions on the exterior walls of contributing properties should be considered as part of a comprehensive maintenance strategy to conserve the contributing property's heritage attributes and cultural heritage value.

It is important to understand the historic assembly of exterior walls and its components prior to planning any interventions. Exterior walls of contributing properties may lack insulation, air or vapour barriers and can be vulnerable to deterioration that affects the interior climate of the building.

Section 4.3.4 and chapter 4.5 of the *Standards and Guidelines for the Conservation of Historic Places in Canada* (2010) provides additional guidelines and best practices on conserving specific cladding materials.

### 5.14.1 Design additions and alterations to conserve the historic features and heritage attributes of exterior walls of contributing properties that face the public realm.

- Do not remove or conceal features or heritage attributes of exterior walls that contribute to HYHCD's cultural heritage value.
- Repair rather than replace historic materials of exterior walls.
- Replace only the features and materials that are irreparably damaged, rather than re-cladding the entire elevation or building.
- Do not paint surfaces that were not painted historically. When the opportunity arises, remove paint from surfaces on wall features not historically painted and in a manner that does not damage the wall features or materials.
- Repoint brick masonry using an appropriate and compatible mortar mixture and traditional pointing methods.
- Do not remove or conceal the patina of age or irregularities found in older work and materials.

### 5.14.2 When the replacement of historic features of exterior walls of contributing properties is necessary, replacements must be in-kind, maintaining the original composition, materials, size, finishes, patterns, detailing, tooling, colours, and features and components of the original.

### 5.14.3 When the replacement of non-historic features of exterior walls of contributing properties is necessary, restore features to their original condition based on documentary evidence. Where sufficient documentary evidence is not available, replacements must be physically and visually compatible with the building, in terms of their composition, materials, size, finishes, patterns, detailing, tooling, colours, and features and components.

### 5.14.4 Design additions with materials that are physically and visually compatible with the contributing property.

### 5.14.5 Exterior historic cladding or features, including wood finishes, stone and brick masonry, and decorative metalwork of contributing properties must be conserved.

- Preserve and maintain features of exterior walls including their varying material finishes using recognized and appropriate conservation methods.
- Clean materials only when necessary, to remove heavy soiling or graffiti, and choose a gentle cleaning method that does not damage building material.
- Test proposed interventions to establish whether the conservation treatment will damage the materials or features of the exterior walls.
- Protect adjacent materials from accidental damage during maintenance work.



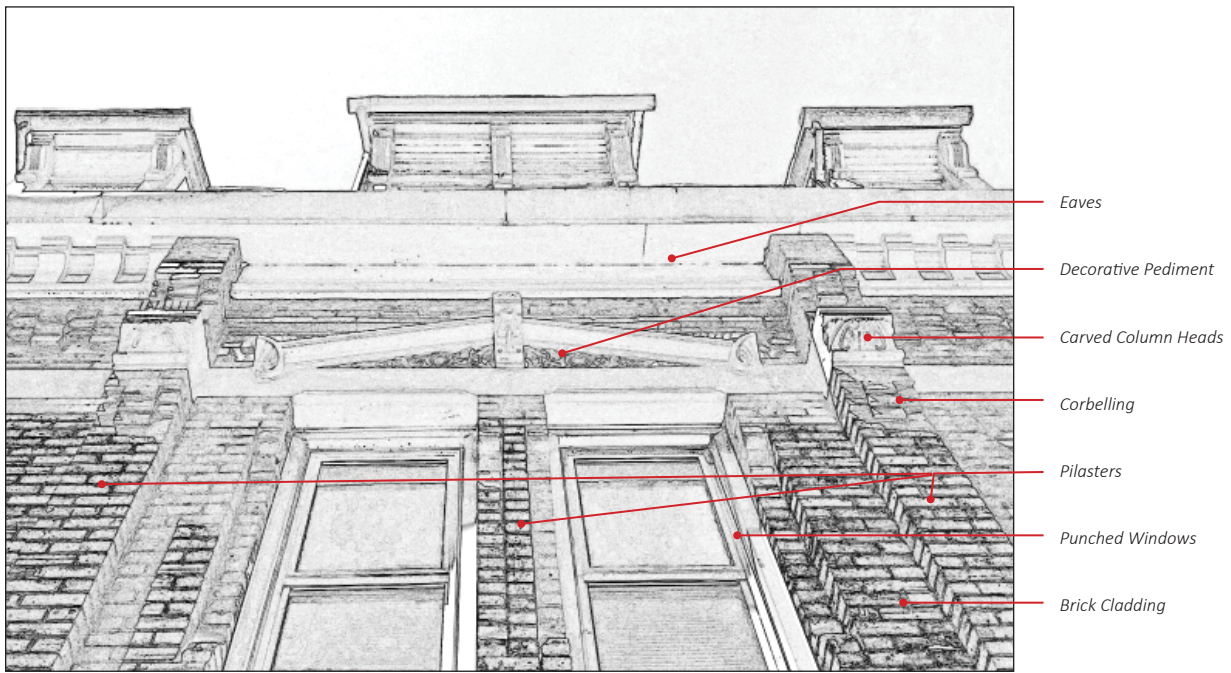

**Wall Features**

*This diagram shows common features of walls.*

## 5.15 SIGNAGE

This section provides direction on incorporating commercial signage to conserve and not detract from the heritage attributes and cultural heritage value of HYHCD. Applications for new commercial signage will be reviewed in accordance with the City of Toronto's Sign By-law.

Commercial activity has been an element of daily life in HYHCD throughout its history. Signage advertising the services and commodities of businesses contributes a dynamic and varied quality to HYHCD's appearance. When preparing a design for new signage within HYHCD, property owners should first consider opportunities to reintroduce a historic signage configuration to a contributing property. This work should be informed by documentary evidence of a building's historic condition.

### 5.15.1 Design signage for contributing properties to be physically and visually compatible with the heritage attributes and cultural heritage value of HYHCD including the scale and rhythm of building frontages.

- Locate and design signage so that it does not detract from or obscure the heritage attributes of a contributing property, including features of exterior walls, roofs, windows, storefronts, and the scale and rhythm of building frontages.
- Signage must not cover windows.
- Signage should be limited to the first floor façade and should not extend to upper floors.
- Consider using historical precedents to inform the design of new signage on contributing properties.

### 5.15.2 Design and mount signage so that its removal will not negatively impact the integrity of exterior walls, including material cladding of contributing properties.

- If signage is being mounted directly on a building, make attachments through mortar joints and not masonry units, using non-corrosive fasteners.

### 5.15.3 The following signage types may be permitted on the first floor of contributing properties:

- **Fascia signs: attached to or supported by a fascia board which projects no more than 0.5m from the wall.**
- Locate fascia signs on storefront fascias only.
- Back-lit signs of single letters may be permitted.
- Neon signs may be permitted.

### - **Projecting signs: signage attached to or supported by the wall of a building which projects more than 0.5m from the wall.**

- Locate projecting signs in proximity to entrances.
- Design projecting signs to be higher than entrances to a property.
- Design projecting signs so that they do not project more than 1.25m from the exterior wall of a building.
- Mount projecting signs so they cover a minimal amount of the exterior wall. A sign's base should not be wider than the sign itself.
- Back-lit signs of single letters may be permitted.
- Neon signs may be permitted.

### - **Externally illuminated signs: projecting signage or fascia signage that is lit by an artificial light source located external to the sign.**

### - **Painted glass signs, and signs adhered to the interior of a window and that do not cover more than 15% of the window.**

### 5.15.4 The following signage types will not be permitted on contributing properties:

- **Third party signs that are not related to the occupants or programming of the property**
- **Banners and suspended fabric signs**
- **Box-style back-lit illuminated signs**
- **Digital display screens**
- **Moving signs with mechanical, automated, elements**
- **Signage installed, or protruding from, the roof**

### 5.15.5 Conserve painted signs on the sidewalls of contributing properties that date from the period of significance.



**Appropriate Signage**

*Sign mounted to fascia board, with no internal illumination.*

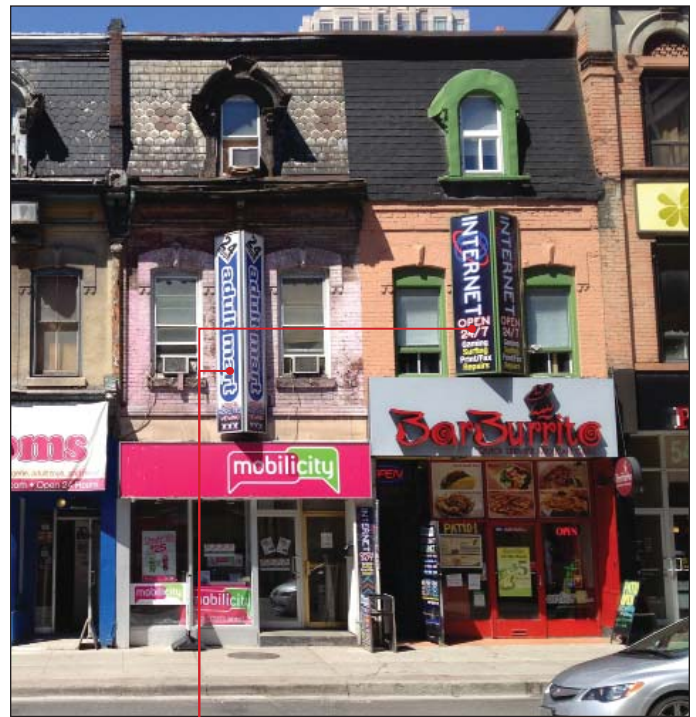

**Non-permitted Signage**

*Signage covering too much building façade, inappropriate size.*

## 5.16 VIEWS & KEY VIEW SITES

Within HYHCD there are contributing properties on which are located prominent buildings or structures that stand out for their architectural detail and location and serve as landmarks within HYHCD. The prominent buildings and views towards them are important heritage attributes of HYHCD and their long-term conservation is a priority of this Plan.

**5.16.1 Interventions to buildings on contributing properties identified as key view sites will be held to the highest standard of conservation.**

**5.16.2 Additions and alterations to buildings on contributing properties identified as key view sites, and to contributing properties adjacent to key view sites must not obstruct views to key view sites. Design additions and alterations to be physically and visually compatible with, subordinate to, and distinguishable from the contributing property.**

**5.16.3 Views identified in this Plan from the public realm towards key view sites, as identified below, must be maintained and conserved.**

**i) Views towards College Park (444 Yonge Street) as identified in the *Official Plan*:**

- College Park can be viewed from several vantage points within the Yonge Street corridor. The entirety of its east facing façade can be viewed from the north east corner of Yonge Street and Wood Street. The entire north facing façade can be viewed from College Street and the north east corner of Bay Street. Both façades can be viewed together from the north east corner of Yonge Street and Carlton Street.

**ii) Views toward Oddfellows Hall (2 College Street and 450 Yonge Street) as identified in the *Official Plan*:**

- The Oddfellows' Hall located on the north west corner of Yonge Street and College Street can be viewed from several vantage points along the Yonge Street and College/Carlton Street corridor. The east facing façade and towers of the property can be viewed from the north east corner of Alexander Street and Yonge Street, as well as from the south east corner of Carlton Street and Yonge Street. The property can be

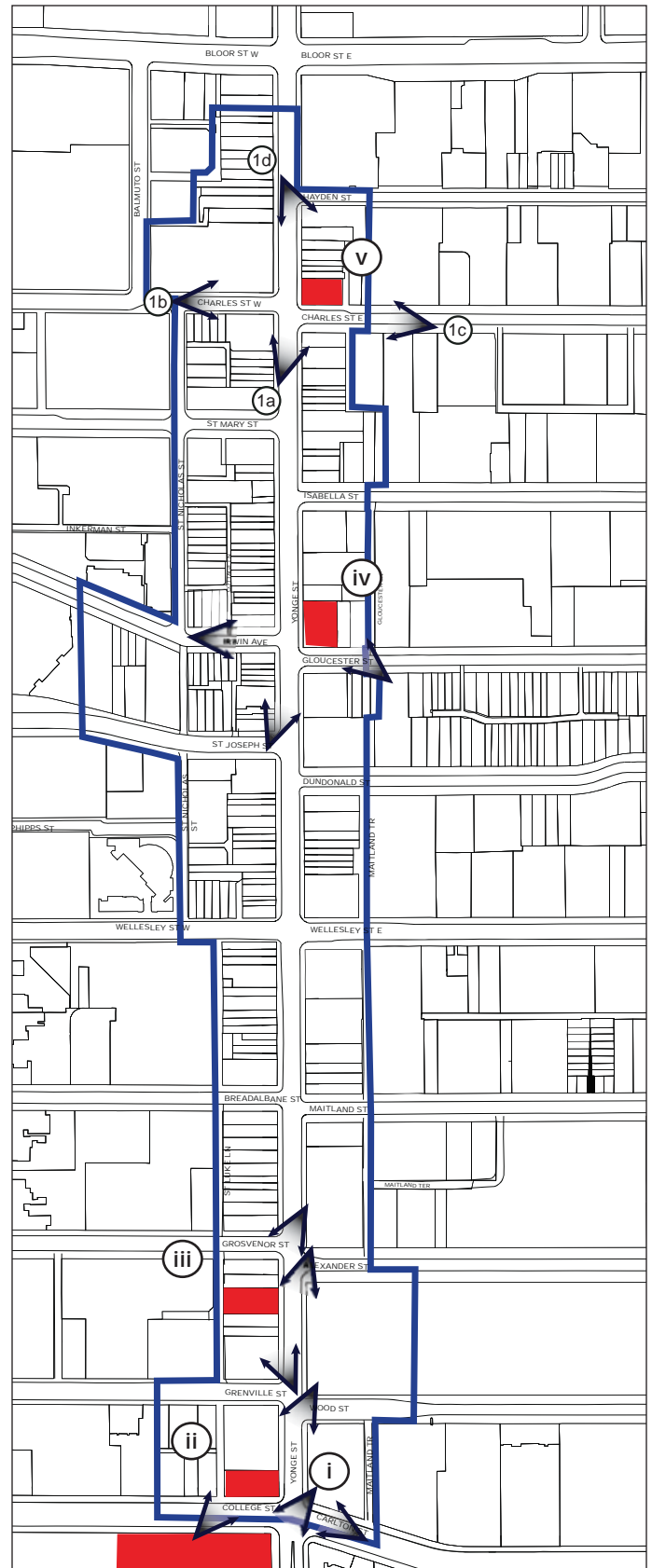

**Key Views & View Sites within HYHCD**



## 5.17 CODE COMPLIANCE AND ACCESSIBILITY

seen in its entirety from the south east corner of Yonge Street and Carlton Street as well as from the sidewalk on the south side of Carlton Street in front of the driveway entrance to 25 Carlton Street.

### iii) Views towards the Clock Tower (484 Yonge Street) as identified in the *Official Plan*:

- The fire hall clock tower on the west side of Yonge Street, located mid-block between Grenville Street and Grosvenor Street can be viewed from the corners of Grosvenor Street and Yonge Street as well as the corners of Grenville Street and Yonge Street. The tower is also a prominent view from the west side of Yonge Street between the south side of College/ Carlton Street and north side of Charles Street.

### iv) Views towards the Masonic Hall (601-613 Yonge Street, 2 Gloucester Street) as identified in the *Official Plan*:

- The Masonic Hall at the north east corner of Yonge Street and Gloucester Street can be viewed in its entirety looking north from the north-west corner of Yonge Street and St. Joseph Street. The prominent tower and west facing face can be viewed from Irwin Avenue and St. Nicholas Lane as well as Cottage Lane. Its southern façade and corner tower can also be seen from the south side of Gloucester Street when viewed from the northern entry to James Canning Park.

### v) Views towards Postal Station F (675 Yonge Street) as identified in the *Official Plan*:

- Postal Station F can be viewed from several point along Yonge Street and streets intersecting with it. Its south and west façades can be viewed looking north from Yonge Street and St. Mary Street. The west façade and building face can be viewed looking east from Charles Street West. Its the south façade can be viewed looking northwest from Charles Street East. And its west façade as viewed looking south from Yonge Street and Hayden Street.

#### 5.16.4 Views identified in this Plan will be added to the City of Toronto's *Official Plan* through an *Official Plan Amendment*.

This plan supports the inclusive design of private and public spaces such that they are physically accessible to all people in accordance with the Accessibility for Ontarians with Disabilities Act.

#### 5.17.1 Design additions and alterations that provide access to a contributing property, such as ramps and mobility assistance devices, in such a way that they do not negatively impact the heritage attributes and cultural heritage value of the property.

- Additions and alterations proposed to provide physical access should be carefully planned and designed to minimize physical and visual impact.
- Additions and alterations should be located in such a way that they do not obscure, remove, or conceal heritage attributes, or important features of the contributing property.
- Where possible locate accessibility features within new additions.

#### 5.17.2 Design retrofits, new additions, and alterations to codes and standards pertaining to health, safety, security, accessibility and sustainability requirements in a way that does not detract from the heritage attributes and cultural heritage value of the contributing property.

## 5.18 SUSTAINABILITY

Conservation work can be planned so that sustainability objectives are also achieved. Consideration must be given to initiatives that improve the sustainability and environmental performance of a building and do not detract from the cultural heritage value and heritage attributes of HYHCD.

Historic buildings also have sustainable qualities, including, but not limited to: materials with a long life cycle; materials that can be repaired rather than replaced; operable windows, which allow for air flow and temperature control; and, windows and skylights which contribute to daylighting. Additional guidance for achieving conservation and sustainability objectives is provided in sections 4.3.1, 4.3.3, 4.3.4, and 4.3.5 of the *Standards and Guidelines for the Conservation of Historic Places in Canada*.

### **5.18.1 Design alterations and additions to contributing properties to achieve sustainability objectives, while conserving HYHCD's cultural heritage value.**

- Do not detract from the cultural heritage value or conceal the heritage attributes of the contributing property when undertaking interventions to improve a building's sustainability performance, including upgrades to the building envelope to improve energy conservation.
- Do not over-clad building envelopes with insulation panels or other finishes that conceal historic features or heritage attributes.

### **5.18.2 Design new features to meet sustainability objectives in a manner that respects the contributing property's exterior form, and does not detract from HYHCD's cultural heritage value.**

- Where possible, locate and design green roofs, reflective roofs and solar panels so that their elements are not visible from the public realm.

## 5.19 OVER-CLAD BUILDINGS

Several contributing properties within HYHCD have been over-clad in such a way that portions of the building have been obscured or concealed. Although these properties contribute to the character of HYHCD, the removal of over-cladding may reveal architectural features that strengthen its contribution.

For the purposes of this Plan, these properties have been identified as contributing for their contextual value, and the policies for contributing properties apply. If a Heritage Investigation demonstrates, to the satisfaction of the City, that a property's historic building features remain, then uncovered architectural features will inform the design of any proposed work. Over time, lost features may be reinstated based on documentary evidence.

A 'Heritage Investigation' in the context of this document refers to a physical investigation that can determine the integrity of a building's features that have been over-clad. It may also include documentary research and evidence such as historic photographs, plans, and drawings. The scope of this investigatory work should be determined in consultation with Heritage Preservation Services Staff during a pre-application meeting.

### **5.19.1 Determine the condition of historic building features on over-clad contributing properties with a Heritage Investigation which must be prepared to the satisfaction of the City. Supplement physical investigation with historic research and documentation of the building's original condition and use the investigations findings to inform the design of any additions or alterations.**

- Historic research and documentation must be prepared to the satisfaction of the City and submitted in support of any building permit on a contributing property that has been over-clad.
- Research should consider the contributing property's period of construction, its builder and architect, if known, and the history of alteration work undertaken on the property.
- Depending on the nature of work proposed, a Heritage Impact Assessment may be required, which is to be prepared to the satisfaction of the City.

### **5.19.2 Preserve the historic building features of an over-clad contributing property.**

- Preserve rather than replace historic building features of over-clad contributing properties.

- Restore only those historic features that have deteriorated beyond repair. Historic features must be restored in-kind, as informed by appropriate research and documentary or physical evidence.

**5.19.3 Restoration of the historic building features of an over-clad contributing property that have been lost is strongly encouraged, where a sufficient amount of historic building fabric and documentary evidence exists to support restoration.**

- Preserve rather than replace historic building features of over-clad contributing properties.
- Restore only those historic features that have deteriorated beyond repair. Historic features must be restored in-kind, as informed by appropriate research and documentation.

**5.19.4 When removing over-clad finishes, employ appropriate methods with the necessary care to not damage the historic building or features beneath.**

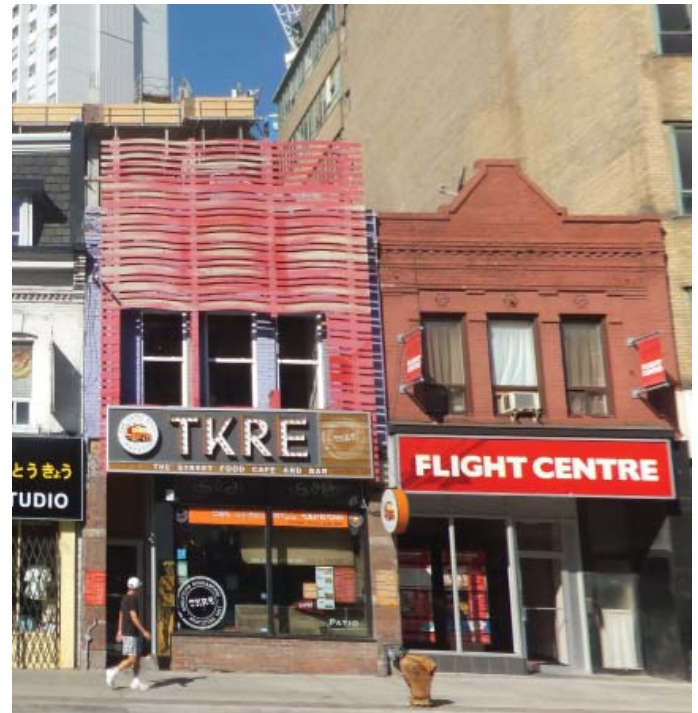

**Over-clad Buildings**

*These buildings have been over-clad with an additional exterior cladding. One has metal paneling, the other a metal lattice where the original façade is visible from some angles.*



# POLICIES & GUIDELINES FOR NON- CONTRIBUTING PROPERTIES

## Introduction

This section contains policies and guidelines for managing alterations, additions, or the redevelopment of non-contributing properties within HYHCD. These policies and guidelines direct change on non-contributing properties in a manner that conserves and enhances the heritage attributes and cultural heritage value of HYHCD. Over time, it is expected that as these properties are redeveloped in accordance with this Plan, they will begin to contribute to the character of HYHCD.

Policies (in **bold** text) set out the general direction for conserving the cultural heritage value of HYHCD, and the guidelines (presented as a bulleted list) provide specific direction on how to achieve those policies. The policies and guidelines are preceded by a short preamble that provides some background to the policy area.

In order to account for specific built form and landscape conditions within HYHCD, this section references four Character Areas (described in section 4.4) identified within HYHCD:

- Historic Yonge Street Character Area
- College/Carlton Character Area
- St. Nicholas Village Character Area
- Residential Pockets Character Area

Definitions have been provided for key words, and included in Appendix A.



## 6.1 UNDERSTANDING

New development must be designed to respect the heritage attributes and cultural heritage value of HYHCD. This does not mean that new development should mimic the architectural style or craftsmanship of the past, nor should it replicate historic architectural styles. New development is encouraged to express the design values of its time, while respecting the cultural heritage value of HYHCD by understanding its character as the first step in designing new development.

### 6.2.1 New development must conserve the heritage attributes and cultural heritage value of HYHCD, while reflecting the design values of its own time.

- New development should not reproduce the design values and style of earlier architectural eras. New development is encouraged to find contemporary design solutions and expression that are in keeping with the requirements of this Plan.

## 6.2 DEMOLITION

Managing change on non-contributing properties, although they do not significantly contribute to the cultural heritage of HYHCD, is critical to conserving its character and sense of place as it evolves. As these properties are redeveloped, it is important that they do not remain vacant for extended periods of time. Managing the timing of construction and demolition is important in this regard.

### 6.2.1 The demolition of buildings on a non-contributing property may be permitted.

### 6.2.2 If permission to demolish a building located on a non-contributing property is granted, demolition activity must not begin until plans for the replacement building(s) have been submitted and approved by the City, and a heritage permit issued.

- New development must conform to the Policies and Guidelines for Non-Contributing Properties as well as all applicable City of Toronto by-laws and processes.
- Substantial progress must be made in the construction of the replacement building(s) within one year of the demolition of the previous building.
- If construction of the replacement building(s) is delayed due to unforeseen circumstances, the City may require interim landscape treatment of the site.

## 6.3 ADDITIONS AND ALTERATIONS

Additions and alterations to non-contributing properties include any work that will increase the volume of the existing building, or will alter its external appearance. These proposals will be evaluated for their impact on the heritage attributes and cultural heritage value of HYHCD as a whole, as well as their Character Area. The policies in this section provide guidance for the design of these interventions.

### 6.3.1 Design additions or alterations to a non-contributing property to be physically and visually compatible with the Character Area in which such property is located, and to not negatively impact the heritage attributes and cultural heritage value of HYHCD.

- Historic Yonge Street Character Area:
  - Additions less than 12m tall should reinforce the streetwall character of HYHCD by being built the full width of the property and to the face of the extant building.
  - Additions taller than 12m will also adhere to policies for building massing.
- College/Carlton Character Area:
  - Additions less than 16m tall should reinforce the streetwall character of HYHCD by being built the full width of the property and to the face of the existing building.
  - Additions taller than 16m tall will adhere to policies for building massing.
- Residential Pockets Character Area & St. Nicholas Village Character Area:
  - Additions should not be located in the front-yard setback of existing buildings.

## 6.4 MASSING

New development and additions must be designed to respect the predominant building height within HYHCD through the use of stepbacks, setbacks, and careful building massing. Contributing properties within HYHCD are typically within 2 - 4 storeys, which imparts a distinct three dimensional character to HYHCD and allows for a high-degree of sun penetration to side streets. This open character is particularly noticeable in contrast to surrounding areas that are more intensely developed.

### 6.4.1 Design new development or additions to a non-contributing property to conserve the predominant building height of the Character Area where the property is found.

- Historic Yonge Street Character Area: New development must be a minimum of 3 storeys. Existing contributing properties are generally 2-4 storeys.
- College/Carlton Character Area: New development must be a minimum of 4 storeys. Existing contributing properties are generally 4-6 storeys.
- St. Nicholas Village Character Area: New development must be a minimum of 2 storeys. Existing contributing properties are generally 2-3 storeys.
- Residential Pockets Character Area: New Development must be a minimum of 2 storeys. Existing contributing properties are generally 2-3 storeys.

### 6.4.2 Design new development or additions to a non-contributing property to conserve the setback condition of the Character Area where the property is found.

- Historic Yonge Street Character Area: The base building, or first three storeys of new development and additions, must be built to the full extent of the front lot line adjacent to a street. Base buildings should generally be built the full extent of side lot lines, except for where the side lot line is adjacent to a street that intersects with Yonge Street and a new public open space is being created.
- College/Carlton Character Area: The base building, or first four storeys of new development and additions, must be built to the full extent of the front lot line adjacent to a street. Base buildings should generally be built the full extent of side lot lines, except for where the side lot line is adjacent to a street that intersects with Yonge Street and a new public open space is being created.

- St. Nicholas Village Character Area: New developments and additions must be set back from the front lot line the average setback distance of contributing properties adjacent to it. New developments and additions should respect the side-yard setback of adjacent buildings. The setback distance can also vary between the side-yards of a building from 0cm - 120cm. Overall, new development should provide an average side-yard setback of between 30cm - 120cm.
- Residential Pockets Character Area: New developments and additions must be setback from the front lot line the average setback distance of house form buildings on contributing properties adjacent to it.

**6.4.3 Design new development or additions to a non-contributing property to conserve the streetwall and three dimensional character of contributing properties in their Character Area.**

- Historic Yonge Street Character Area: Any portion of new development and/or additions taller than 12m above grade must step back a minimum of 10m from any property lot line adjacent to a street, for the entirety of the façade of the development including its balconies.
- College/Carlton Character Area: Any portion of new development and/or additions taller than 16m above grade must step back a minimum of 10m from any property lot line adjacent to a street, for the entirety of the façade of the development including its balconies.
- St. Nicholas Village Character Area and Residential Pockets Character Area: Any portion of new development and/or additions taller than 12m above grade must step back a minimum of 10m from any property lot line adjacent to a street, plus:
  - the average distance between roof ridge lines and building fronts of adjacent contributing properties;
  - and, the average setback distance of adjacent contributing properties.

These stepbacks apply to the entirety of the façade of the development including its balconies.

- 10m stepbacks apply to all property lines that are adjacent to a street, including Yonge Street and all streets intersecting with it.
- Additional setback distances beyond 10m may be determined where the minimum setback does

not conserve the values and attributes of adjacent properties.

**6.4.4 New development or additions to a non-contributing property are subject to a 75 degree angular plane measured at the height appropriate for each Character Area and from each elevation of a building adjacent to and parallel with a street within HYHCD as set out below.**

- The 75 degree angular plan applies to all streets within HYHCD.
- If there is no existing building on the property in question, then the 75 degree angular plane will be measured from each property line adjacent to and parallel with a street that is within HYHCD.
- The 75 degree angular plane will be measured at the following heights:
  - Historic Yonge Street Character Area, St. Nicholas Village Character Area, Residential Pockets Character Area: 12m above grade, as defined by the applicable zoning by-law.
  - College/Carlton: 16m above grade, as defined by the applicable zoning by-law.

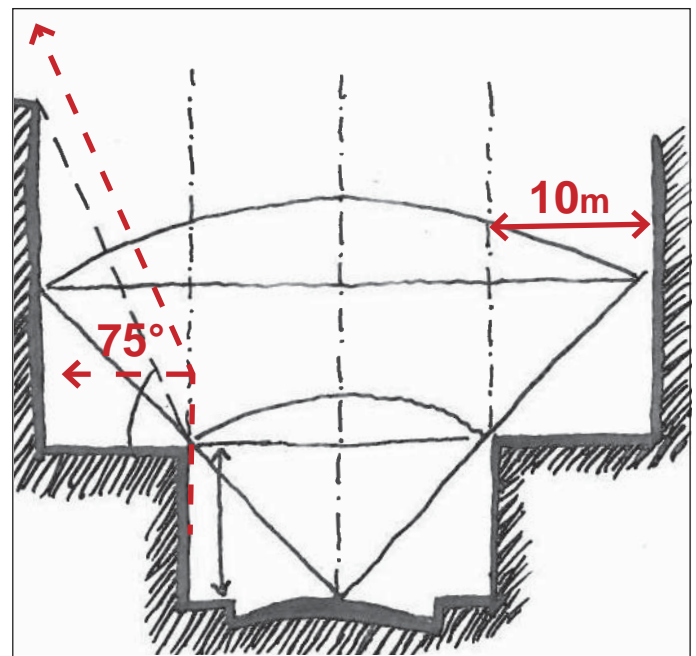

**Stepbacks and Angular Planes**  
 New development within HYHCD must conform to a 75 degree angular plane and 10m stepback.

## 6.5 FAÇADE PATTERNS AND FEATURES

Contributing properties within HYHCD display a strong rhythm of horizontal and vertical articulations in their façade. This rhythm is reinforced by the fine-grained vertical divisions of storefronts and building bays, as viewed in elevation, of between 3 and 7 metres wide, which also carries over to the lot width of residential areas.

Historic buildings within HYHCD have particular glazing ratios that varies with their original use. These buildings are generally less transparent than contemporary buildings.

New development must respect and respond to the horizontal and vertical rhythm of the façades of contributing properties within the same block (primarily) or within their Character Area (secondarily).

### 6.5.1 Design new development and additions to conserve the horizontal rhythm articulated in the façades of adjacent contributing properties.

- Articulate the transition between floors in the façade design of buildings that form part of the streetwall.
- Align storefront heights with the storefront heights of adjacent contributing properties.
- Align horizontal façade articulation with the articulation of adjacent contributing properties.
- Where there are no adjacent contributing properties follow the horizontal rhythm of properties on the same block that are part of the streetwall.

### 6.5.2 Design new development to provide retail bays of between 3 and 7 metres wide (ideally 4.5 metres) along streets that are appropriate to each Character Area.

- Historic Yonge Character Area: New development fronting onto Yonge Street must provide retail bays at grade for the full extent of the property's frontage.
- College/Carlton Character Area: New development fronting onto Yonge Street must provide retail bays at grade for the full extent of the property's frontage.
- Residential Pockets Character Area: New development may provide retail bays at grade.
- In all Character Areas where retail bays are provided, they should not be higher than 1 storey (approximately 4.5 metres). Double height retail bays are not permitted.
- Retail bays should have operable doors.

### 6.5.3 Design new development to conserve the vertical rhythm articulated in the façades of adjacent contributing properties.

- Divide building façades in a way that reflects the predominant building widths of adjacent contributing properties.
- The division of upper storey façades must align with the division of at-grade retail bays, where they exist.
- Where there are no adjacent contributing properties follow the vertical rhythm of properties on the same block that are part of the streetwall.

### 6.5.4 Design new development with windows and opportunities for access and egress, and not blank walls, towards streets or open spaces within HYHCD.

### 6.5.5 The façade of any new development and addition that is visible from the public realm and not stepped back from a building face or lot line shall be designed with only punched windows.

- Include punched windows in the façade design of any other portion of the façade that is visible from the public realm and not stepped back from a building face or lot line.

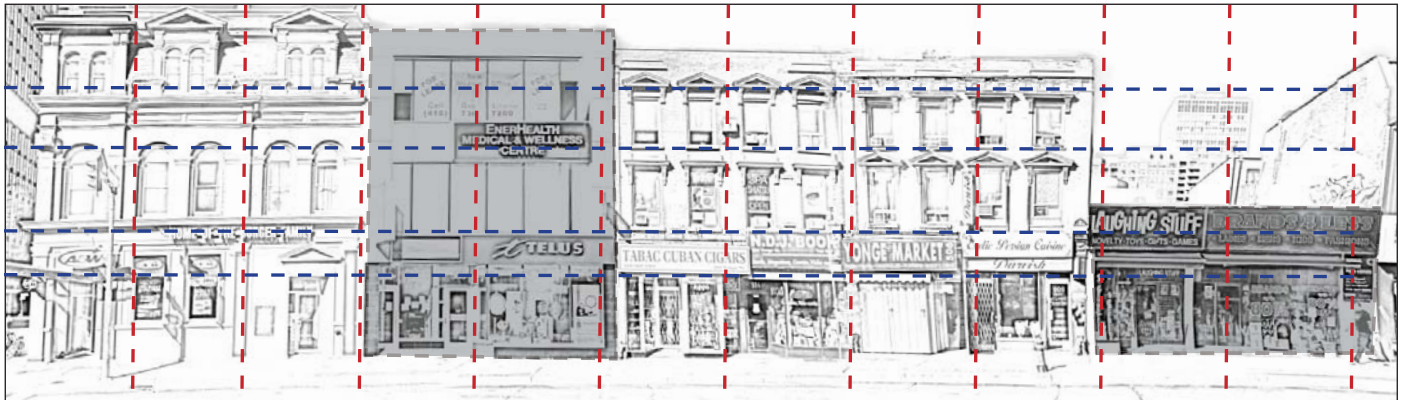

**Façade Articulation**

*This illustration shows how two non-contributing buildings façade articulation should be informed by the horizontal (blue) and vertical (red) articulation of adjacent contributing buildings.*

## 6.6 WINDOWS & FENESTRATION

Windows and the detailing that surrounds them are a key architectural element on buildings, and a strong contributor to the building's character. Within HYHCD there is a distinct pattern of glazing ratios within Character Areas that is driven largely by the building's original use.

It is important for new development and additions within HYHCD to respond to these glazing ratios in their design.

### 6.6.1 Design new development and additions to respect the pattern of glazing on contributing properties in their Character Area at grade.

- Historic Yonge Street Character Area: New development and additions must include approximately 80% glazing within the first storey above grade (no more than 90% and no less than 70%) for the full extent of the property fronting onto Yonge Street. Upper storeys of a building not stepped back from a building face or lot line must provide between 40% and 50% glazing on each storey.
- College/Carlton Character Area: New development and additions fronting onto Yonge Street within the first storey at grade must include approximately 80% glazing (no more than 90% and no less than

70%) for the full extent of the property fronting onto Yonge Street. Upper storeys of a building not stepped back from a building face or lot line must provide between 40% and 50% glazing on each storey.

- St. Nicholas Village Character Area: New development and additions must provide a consistent proportion of glazing between 40% and 50% on ground and upper storeys for the portion of the building facade not stepped back from a building face or lot line.
- Residential Pockets Character Area: New development and additions must provide a consistent proportion of glazing between 40% and 50% on ground and upper storeys for the portion of the building facade not stepped back from a building face or lot line.

### 6.6.2 Include punched windows in the design of buildings for the portion of the building facade that is not stepped back from a building face or lot line.

- Portions of a building facade that are stepped back from a building face or lot line should be designed with a greater proportion of glazing to create a lighter visual appearance and contrast with the historic character of buildings above.



#### Mixed-use Building Glazing

Glazing ratios of ground and upper storeys on mixed-use buildings.



#### Residential Building Glazing

Glazing ratios of ground and upper storeys on residential buildings.

## 6.7 ROOFS

A building's roof helps to delineate its height, massing, and relationship to the public realm. New development and additions should be designed with consideration for the roof of surrounding contributing properties including any new roof top elements. In this section an apartment-form building refers to residential buildings of two or more storeys with multiple dwelling units and a single primary entrance.

### 6.7.1 Design new development and additions to respect the roof character and design of contributing properties in their Character Area.

- Historic Yonge Street Character Area & College/Carlton Character Area: New development and additions may include flat roofs, or roofs sloped towards Yonge Street or College/Carlton Street, as applicable. Roofs shall not slope at right angles to Yonge Street, except features such as dormers or bays.
- St. Nicholas Village Character Area & Residential Pockets Character Area: New development and additions should include sloped roofs in house-form buildings. Apartment-form buildings may be designed with flat roofs.

### 6.7.2 Locate new rooftop elements such as mechanical penthouses, vents, drainage components, sustainable technologies, including solar panels or wind generators, satellite dishes, skylights, metal chimneys, flutes, and decks to be out of view of the public realm.

## 6.8 MATERIALITY & WALL DESIGN

New development and additions should be designed with a selection of materials and finishes that respects and responds to the heritage attributes and cultural heritage value of HYHCD. The materials of new development and additions that occupy a built context similar to adjacent contributing properties should be given higher priority than any stepped back portions of the new development or addition. Contemporary materials may be used to create a contrast between new development and historic buildings. For tall buildings these materials add a lightness to a building and mitigate some of its visual impact.

### 6.8.1 Use cladding materials that are physically and visually compatible with the heritage attributes and cultural heritage value of HYHCD and the Character Area of the property.

- Historic Yonge Street Character Area & College/Carlton Character Area:
  - Use brick masonry and/or stone in the articulation of architectural details, such as columns or pilasters used to demarcate retail bays and breaks in the building's façade along the streetwall.
  - Contemporary materials, such as glass or metal, may be permitted in the storefront of a retail bay, providing they do not negatively impact the heritage attributes and cultural heritage value of HYHCD.
  - Contemporary materials, such as glass or metal, may be permitted for portions of new development which are stepped back from a building face or lot line, providing they do not negatively impact the heritage attributes and cultural heritage value of HYHCD.
- St. Nicholas Village Character Area & Residential Pockets Character Area:
  - Use brick masonry and/or stone in the articulation of architectural details that make up the portion of a building that is not stepped back from a building face on the same property.
  - Contemporary materials, such as glass or metal, may be permitted for portions of new development which are stepped back from a building face on the same property, providing they do not negatively impact the heritage attributes and cultural heritage value of HYHCD.

## 6.9 VIEW CORRIDORS & LANDMARKS

Within HYHCD there are several non-contributing properties that serve as the terminus of a view corridor. As these properties are redeveloped, they present a unique opportunity to contribute to the character of HYHCD with enhanced design treatment and articulation. As such they also serve as wayfinding elements and support connectivity and circulation throughout HYHCD.

### 6.9.1 Redevelopment of non-contributing properties that are identified as view termini, or are within gateways to HYHCD, will be held to high standards for architectural design and articulation.

- Certain properties have the potential to function as landmarks within the HYHCD, and should receive a high degree of design investment and attention.



View Corridors & View Termini

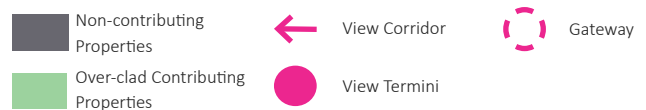



## 6.10 SIGNAGE

As a District with a distinct commercial character and history of commercial activity, signage in HYHCD is an important component of the overall look and feel of HYHCD. Although contributing properties may reference historical sign design and configurations, non-contributing properties should pursue a contemporary design, subject to the policies and guidelines in this section.

These policies provide direction on incorporating commercial signage to conserve and not detract from the heritage attributes and cultural heritage value of HYHCD. Applications for new commercial signage will also be reviewed in accordance with the City of Toronto's Sign by-law and the definitions and regulations specified therein.

### 6.10.1 Design signage to be physically and visually compatible with the heritage attributes and cultural heritage value of HYHCD including the scale and rhythm of building frontages.

- Locate and design signage so that it does not detract from or obscure the building features of a property, including features of exterior walls, roofs, windows, storefronts, and the scale and rhythm of building frontages.
- Signage must not cover windows.
- Signage should be limited to the ground floor façade and should not extend to upper floors.

### 6.10.2 The following signage types may be permitted on the first floor:

- **Wall or fascia signs: attached to or supported by a fascia board which projects no more than 0.5m from the wall.**

- Back-lit signs of single letters may be permitted.
- Neon signs may be permitted.

- **Projecting signs: signage attached to or supported by the wall of a building which projects more than 0.5m from the wall.**

- Locate projecting signs in proximity to entrances.
- Design projecting signs to be higher than entrances to a property.
- Design projecting signs so that they do not project more than 1.25m from the exterior wall of a building.

- Mount projecting signs so they cover a minimal amount of the exterior wall. The area of the sign closest to the wall should not be wider than the sign itself.
- Back-lit signs of single letters may be permitted.
- Neon signs may be permitted.

- **Externally illuminated signs: projecting signage or fascia signage that is lit by an artificial light source located external to the sign.**

- **Painted glass signs, and signs adhered to the interior of a window and that do not cover more than 15% of the window.**

### 6.10.3 The following signage types will not be permitted:

- **Third party signs that are not related to the occupants or programming of the property.**

- **Banners and suspended fabric signs.**

- **Box-style back-lit illuminated signs.**

- **Digital display screens.**

- **Moving signs with mechanical, automated elements.**

- **Signage installed on, or protruding from the roof.**

## 6.11 POLICIES FOR ADJACENT PROPERTIES

### 6.11.1 ADJACENCY TO THE DISTRICT

The *Official Plan* (through OPA 199) includes policies governing alterations, development, municipal improvements and/or public works on properties adjacent to Heritage Conservation Districts. Refer to these policies before undertaking any work on a property adjacent to HYHCD.



# POLICIES & GUIDELINES FOR LANDSCAPES

## Introduction

This section contains policies and guidelines for the conservation of landscapes within HYHCD. Policies (in **bold** text) layout the general rules for conserving its cultural heritage value. The guidelines (presented as a bulleted list) provide specific direction on how to achieve these policies.

In order to account for specific landscape conditions within HYHCD, this section references four Character Areas (described in section 4.4) identified within HYHCD:

- Historic Yonge Street Character Area
- College/Carlton Character Area
- St. Nicholas Village Character Area
- Residential Pockets Character Area

Definitions have been provided for all key words, and included in Appendix A.

## 7.1 LANEWAYS

Laneways are an important component of HYHCD's character and indicative of its historic development and boundaries. Furthermore these routes serve several important functions. As service delivery routes they keep service traffic off of Yonge Street and support its ongoing function and character as an overland transportation route. They also serve as auxiliary pedestrian circulation routes, helping to absorb some of the pedestrian traffic in the area.

Within HYHCD there are both "blind" laneways that dead-end and cannot be used for circulation and "through" laneways that are used for circulation.

### 7.1.1 Conserve public laneways within HYHCD as publicly accessible circulation routes.

- Laneways should continue to serve as service connections for businesses with a frontage on Yonge Street, and as part of the broader pedestrian circulation network.
- Any road or utility work planned for laneways must recognise the ongoing use of these routes by pedestrians, and plan for their continued use by pedestrians in the future.
- Laneways must be accessible at all hours of the day and times of year.
- Business servicing and delivery hours should be coordinated so as to maintain the use of a laneway as a circulation route.

### 7.1.2 As the opportunity arises, public laneways should be enhanced with landscaping and lighting treatments to create a pedestrian-friendly environment.

### 7.1.3 If blind laneways are conferred to a private entity for the purpose of land consolidation and redevelopment then an equivalent amount of publicly accessible space should be provided on the site.

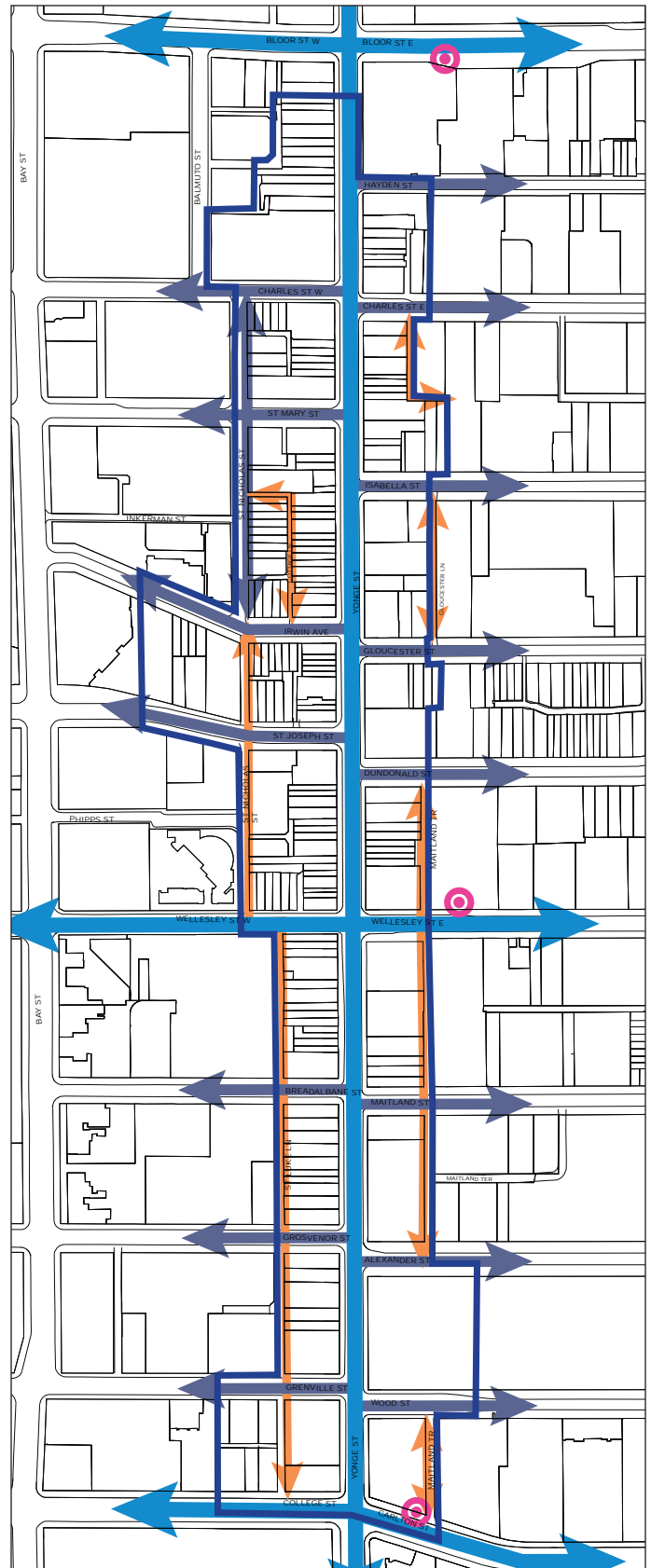

Laneways & Circulation Route Hierarchy

- ← Primary Circulation Route
- ← Secondary Circulation Route
- ← Laneways
- Subway Station

## 7.2 STREET TREES

Street trees have come to mark an important contrast within HYHCD. Secondary circulation routes are generally treed and have a residential streetscape; whereas primary circulation routes such as Yonge Street are not treed and have a mixed-use and commercial streetscape. This Plan supports the creation and retention of a strong and healthy tree canopy on side streets throughout HYHCD.

**7.2.1 Conserve existing street trees within HYHCD, and strengthen these trees with appropriate arboriculture treatment, including pruning and pest management.**

**7.2.2 The “greening” of side streets intersecting with Yonge Street is encouraged, particularly for new development and additions which should have a landscaped perimeter alongside the public realm.**

- New street trees should be selected to effect a compatible visual appearance with other trees in HYHCD, not to create a homogeneous tree stock, but to create an overall cohesive appearance.
- Street trees should be planted, and in a boulevard where one exists along a side street. Where one does not exist they may be planted flush with the sidewalk with a tree grate covering their base. Street trees should not be planted in planter boxes.

## 7.3 PARKING

As a densely developed urban environment parking within HYHCD is generally limited to structured below-ground parking, with some additional parking on side streets. There is only one surface parking lot in HYHCD, and no further surface parking lots should be created. As HYHCD continues to develop, any additional parking should be accommodated underground with appropriate access and screening to make a minimal impact (physical and visual) on the public realm.

**7.3.1 Do not create new surface parking lots within HYHCD.**

- Expansion of existing surface parking lots is prohibited.
- Removal of existing surface parking lots is encouraged.

**7.3.2 Locate parking areas for new development underground.**

## 7.4 PRIVATELY OWNED PUBLICLY-ACCESSIBLE SPACE (POPS)

Although there are no POPS within HYHCD, there may be some opportunities to create them in the future. The key consideration in doing so will be maintaining the historic setbacks of HYHCD's Character Areas.

### 7.4.1 Investigate opportunities for new POPS as new development is proposed within HYHCD.

### 7.4.2 Do not create POPS that will disrupt the historic setbacks of Character Areas within HYHCD, including the streetwall.

- POPS should be designed as open to the public realm and free of any barriers, including but not limited to: fences, planter boxes, and planter beds integrated with the sidewalk.
- Historic Yonge Street Character Area and College/Carlton Character Area:
  - Do not incrementally disrupt the integrity of the streetwall on a block.
  - POPS may be incorporated along streets intersecting with Yonge Street, and should have a frontage to both Yonge Street and the street it intersects with.
- St. Nicholas Village Character Area & Residential Pockets Character Area:
  - POPS may be provided in the required setback area along a building frontage.

## 7.5 UTILITIES AND PUBLIC WORKS

In planning and undertaking maintenance and upgrading work for public infrastructure, a key design principle and objective should be de-cluttering the public realm of unnecessary objects, particularly objects that would detract from views towards contributing properties, or from the use of the sidewalk including during civic gatherings and celebrations.

### 7.5.1 Utility companies and City departments undertaking ongoing maintenance and improvements to utility infrastructure are encouraged to advise Heritage Preservation Services Staff prior to undertaking any work in HYHCD.

- Use the HCD Plan objectives to guide the planning and execution of public works projects within HYHCD.
- Design and locate permanent infrastructure so that it does not obstruct views of prominent buildings, or contributing properties.

### 7.5.2 Hide new public utilities and upgrades of existing utilities from view of streets and open spaces, wherever possible.

- Electrical boxes, cables, and wiring should be buried wherever possible, or contained within buildings.
- If an access or service box for utility infrastructure cannot be buried, than it should be located on side streets wherever possible.

### 7.5.3 Widening of sidewalks is desirable, but should only be undertaken where it can be achieved while retaining the historic streetwall condition.

- It is preferable to widen sidewalks by altering the configuration, width, and/or number of traffic lanes.

## 7.6 LIGHTING & STREET FURNISHINGS

Lighting, and particularly pedestrian scale lighting, helps to contribute to the pedestrian friendly character of HYHCD while creating an overall sense of safety and security. In keeping with the approach to utilities and public works, any new lighting or street furnishings should aim to de-clutter the street in order to support a comfortable experience for pedestrians, and to not obstruct views of contributing buildings.

As part of a public realm improvement plan, new lighting could be designed for HYHCD that would reinforce its character and sense of place. Any new design should reference and be symbolic of its character while achieving the objectives noted above. Lighting design should consider historical precedents, but need not necessarily replicate a historical lighting design.

### **7.6.1 Design new lighting within HYHCD to be pedestrian scaled and cohesive. Any new street lighting must be implementable District-wide.**

- New lighting may be affixed to the exterior wall of properties so long as it does not damage the building and is physically and visually compatible with, and does not detract from, the heritage attributes and cultural heritage value of HYHCD.

### **7.6.2 Remove high pressure sodium wall lights from the façade of contributing and non-contributing properties as the opportunity arises.**

- Within HYHCD there are multiple instances where high pressure sodium lights have been affixed to the exterior wall of a building facing Yonge Street. These should be removed throughout HYHCD, as the opportunity arises, and replaced with appropriate pedestrian scaled lighting.

### **7.6.3 Incorporate electrical outlets into new lighting poles within HYHCD.**

- Including electrical outlets and/or connections into light standards will support the ongoing use of HYHCD as a civic gathering space.
- Consider probable and preferred locations for hosting events and/or seasonal decorations that may require electricity when planning for additional electrical connections. It may not be necessary to provide connections at every light pole.

### **7.6.4 Planter boxes and additional street furnishings such as benches are not permitted on the sidewalk along Yonge Street.**

- If there is interest in adding decorative plantings to Yonge Street they should be designed as fixtures to light standards above pedestrian height.
- If there is interest in adding temporary banners to advertise festivals, or a Business Improvement Area they should be incorporated as fixtures to light standards above pedestrian height.
- Yonge Street's narrow sidewalks and high volume of pedestrian traffic are not conducive to street furnishings such as benches. Additional seating may be incorporated on side streets intersecting with Yonge Street or in new POPS that are properly located on side streets as per section 7.4. Alternatively, if the sidewalk is widened by reducing the space for travel lanes, then additional furnishing such as benches may be considered.

## 7.7 CIRCULATION

HYHCD is, and has historically been, a major transportation route. While this Plan is supportive of this ongoing role and function, it recognizes the ongoing need to balance the needs of multiple users within the public right-of-way.

**7.7.1 Permanent or temporary road traffic closures along Yonge Street to create additional pedestrian space and/or dedicated lanes for cyclists is permitted.**

- Although lane closures are permitted, Yonge Street should continue to be used as a general vehicular circulation route.

**7.7.2 The use of removable bollards and roll curbs may be permitted in areas that have been identified as suitable for permanent or temporary lane traffic closures.**



# ARCHAEOLOGY

## 8.1 POLICY CONTEXT

The City of Toronto's *Archaeological Management Plan* is a more detailed means of identifying general areas of archaeological potential than is possible through the application of general Provincial criteria. The intent of the Management Plan is to ensure that archaeological sites are adequately considered and studied prior to any form of development or land use change that may affect them. The Management Plan also identifies specific areas of known archaeological sites referred to as "Archaeologically Sensitive Areas" (ASAs). These represent concentrations of interrelated features of considerable scale and complexity, some of which are related to single particularly significant occupations or a long-term continuity of use, while others are the product of a variety of changes in use or association through time and therefore constitute an array of overlapping but potentially discrete deposits. The Management Plan has not defined any ASAs within HYHCD at this time.

When redevelopment is proposed for any lands that incorporate areas of archaeological potential, it triggers an assessment and evaluation process (Stage 1 Background Study and Property Inspection) that begins with a detailed reconstruction of the history of occupation and use of the property in order to identify specific features of potential archaeological interest or value and to predict the degree to which they are likely to have survived later development events.

In cases where the Stage 1 study confirms that there is a probability that significant archaeological resources may be present on an urban property, such as those in the HCD, some form of test excavations by a qualified expert are required (Stage 2 Property Assessment). If the results of the excavations are positive, more extensive investigations may be required (Stage 3 Site-Specific Assessment), but often it is possible at the conclusion of the Stage 2 work to evaluate the cultural heritage value of the archaeological remains and to develop any required Stage 4 Mitigation of Development Impacts to minimize or offset the negative effects of the proposed redevelopment. Such strategies may consist of planning and design measures to avoid the archaeological remains, archaeological monitoring during construction, or extensive archaeological excavation and recording of the finds prior to any construction, or some combination of these approaches. Archaeological monitoring and excavation work on site is followed by comparative analyses of the archaeological data that have been recovered ("salvaged") and the interpretation



of those data. The identification of the most appropriate form of Stage 4 mitigation requires close consultation between the consulting archaeologist, the development proponent and their agents and contractors, and the planning approvals and regulatory authorities and must be carried out in accordance with the City of Toronto *Archaeological Management Plan*, the *Official Plan* and applicable Provincial regulations. This overall assessment process generally takes place in the context of development applications requiring Zoning By-law Amendments, Official Plan Amendments, Plans of Subdivision, or Condominium and Site Plan Control.

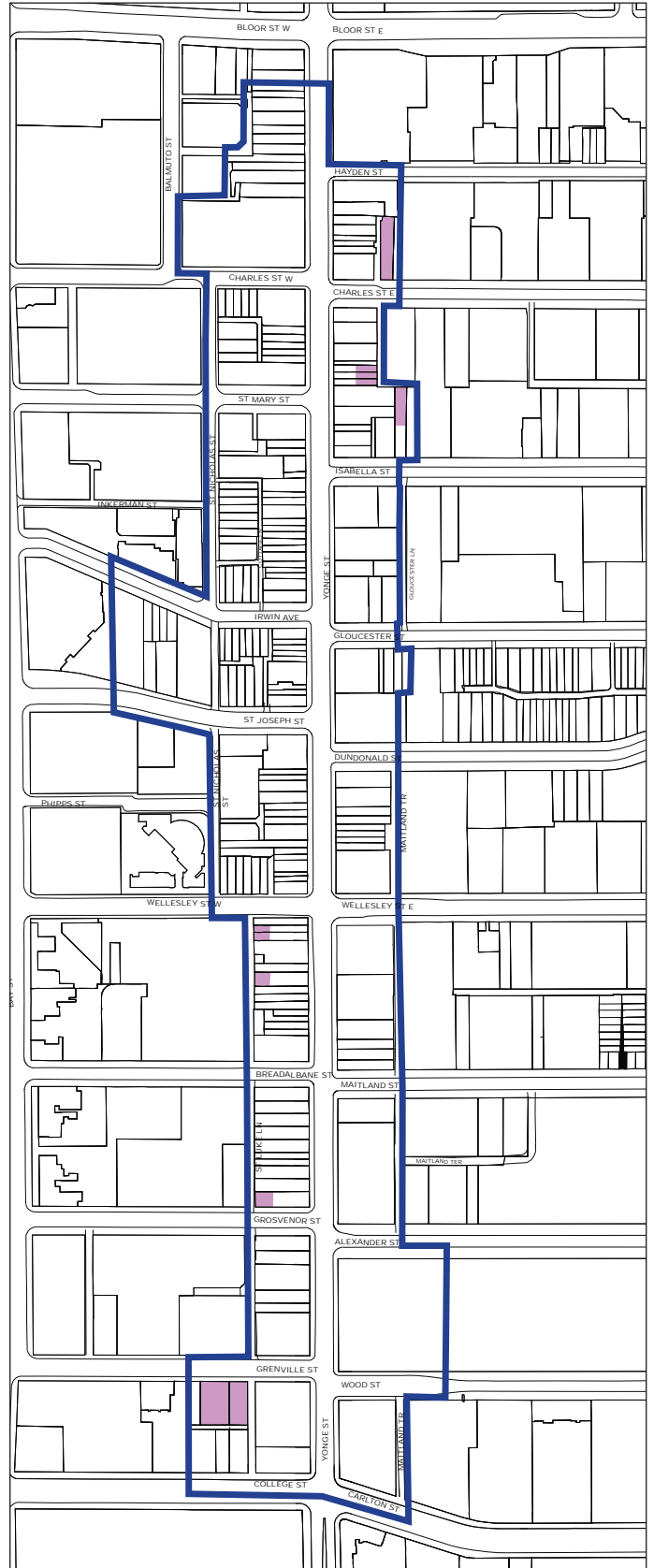

**Areas of Archaeological Potential**

Areas of Archaeological Potential

## 8.2 ARCHAEOLOGICAL RESOURCE REQUIREMENTS

### Areas of Archaeological Potential

Within HYHCD, 18 properties represent, in whole or in part, areas of general archaeological potential. Of these, 13 are contributing properties and five are non-contributing.

In general, the City of Toronto *Archaeological Management Plan* assigns archaeological potential on a simple “yes” or “no” basis. Either a property exhibits archaeological potential or it does not. Research undertaken for the Historic Yonge Street HCD Study and Plan has refined this approach for each of the 18 properties that exhibit archaeological potential by categorizing each property according to the types of activities that would likely require an archaeological assessment, or review of the need for an archaeological assessment, prior to activities that will result in some form of ground disturbance that might not otherwise be subject to archaeological planning control outside of a designated Heritage Conservation District (Table 1). These properties, and the potential alterations of concern, are identified in Table 2.

### Permit Requirements

For properties within areas of general archaeological potential, soil disturbance activities associated with large scale development, such as applications under the *Planning Act*, will be subject to archaeological review by City staff and an archaeological assessment will be required prior to any soil disturbance activity.

Proposed small-scale alterations to contributing properties will be subject to archaeological review by City staff and an archaeological assessment may be required prior to any on-site work that involves:

- Additions to existing structures requiring subsurface disturbances.
- New structures/installations in open space areas within other part(s) of the property requiring subsurface disturbances.
- Foundation repair/alteration to existing buildings.
- New service hook ups or repairs to a building frontage with a minimal setback and originating from the adjacent right-of-way.
- New service hook ups or repairs to a building set back from the right-of-way of origin.

- Landscape alterations requiring subsurface excavation/grade changes.
- Site alteration also includes any construction activities requiring permits or approvals under Provincial legislation, such as the *Planning Act*, or the *Building Code Act*.

Not all contributing properties necessarily require review and/or assessment for all types of identified alterations (see Table 2).

Non-contributing properties within areas of general archaeological potential where soil disturbances associated with large scale redevelopment, such as applications under the *Planning Act*, including Committee of Adjustment applications, will be subject to archaeological review by City staff and an archaeological assessment will be required prior to any on-site work. Small-scale alterations not subject to *Planning Act* control will not, in most cases, require archaeological review/assessment.

In addition to obtaining a permit under Part V of the *Ontario Heritage Act* for any archaeological sites or resources identified as attributes of a District, the procedures for archaeology identified within the *Archaeological Management Plan* must also be complied with where they apply.

**Table 1: Development/Alteration Types for Properties with Archaeological Potential Located in the Historic Yonge Street HCD**

Category	Development/Alteration Type
1	Additions to existing structures requiring subsurface disturbances
2	New structures/installations in open space areas within other part(s) of the property requiring subsurface disturbances
3	Foundation repair/alteration to existing buildings
4	New service hook ups or repairs to a building frontage with a minimal setback and originating from the adjacent right-of-way
5	New service hook ups or repairs to a building set back from the right-of-way of origin
6	Landscape alterations requiring subsurface excavation/grade changes

**Table 2: Properties with Generalized Archaeological Potential and Impact Categories of Concern**

Address	Contributing or Non-contributing	Alterations Requiring Assessment/Review
496 Yonge Street	Contributing	1, 2, 5 (from west), 6
498 Yonge Street	Contributing	1, 2, 5 (from west), 6
552 Yonge Street	Contributing	1, 2, 5 (from west), 6
554 Yonge Street	Contributing	1, 2, 5 (from west), 6
564 Yonge Street	Contributing	1, 2, 6
568 Yonge Street	Contributing	1, 2, 6
647 Yonge Street	Contributing	1, 2, 6
649 Yonge Street	Contributing	1, 2, 6
651 Yonge Street	Contributing	1, 2, 6
653 Yonge Street	Contributing	1, 2, 6
655 Yonge Street	Contributing	1, 2, 6
657 Yonge Street	Contributing	1, 2, 6
659 Yonge Street	Contributing	1, 2, 6
8 Charles Street East	Non-Contributing	Stage 1 assessment required in event of redevelopment
9 Grenville Street	Non-Contributing	Stage 1 assessment required in event of redevelopment
11 Grenville Street	Non-Contributing	Stage 1 assessment required in event of redevelopment
13 Grenville Street	Non-Contributing	Stage 1 assessment required in event of redevelopment
15 Grenville Street	Non-Contributing	Stage 1 assessment required in event of redevelopment



## IMPLEMENTATION & ADMINISTRATION OF THE HCD PLAN

### 9.1 MINOR ALTERATIONS NOT REQUIRING A PERMIT

Owners of property within HYHCD are required to apply for a heritage permit for any proposal that involves the demolition or alteration of any portion of a building within HYHCD that is visible from the public realm. Some alterations, however, are considered minor and under Chapter 103 of Toronto's *Municipal Code* (as adopted by *By-law 1005-2001*) a heritage permit is deemed to be issued for them.

A heritage permit is deemed to be issued for the following alterations to the external portions of a building or structure located in a Heritage Conservation District:

1. Painting of wood, stucco, or metal finishes.
2. Repair of existing features, including roofs, wall cladding, dormers, cresting, cupolas, cornices, brackets, columns, balustrades, porches and steps, entrances, windows, foundations, and decorative wood, metal, stone or terra cotta, provided that the same type of materials are used.
3. Installation of eaves-troughs.
4. Weatherproofing, including installation of removable storm windows and doors, caulking, and weather-stripping.
5. Installation of exterior lights.
6. An alteration that is not visible from a street.

Although a heritage permit is deemed to be issued for the above alterations, property owners and tenants are encouraged to conform with the spirit and intent of this Plan, its policies and guidelines and to reference the *Standards and Guidelines for the Conservation of Historic Places in Canada*.

## 9.2 HCD ADMINISTRATION, INCENTIVES & PROCEDURES

### 9.2.1 HERITAGE PERMIT PROCESS

Owners of property within HYHCD are required to apply for a heritage permit for any alteration that is visible from the public realm and not listed in section 9.1. Proposed work will be reviewed by the City for consistency with this Plan, its policies and guidelines, as well as any other heritage designation by-laws, easement agreements, or heritage protections registered on the property.

This Plan, its policies and guidelines, do not apply to the alteration of building interiors, or building exteriors that are not visible from the public realm.

### 9.2.2 INCENTIVES FOR CONSERVATION

The City provides several incentives for heritage conservation that are administered through Heritage Preservation Services,

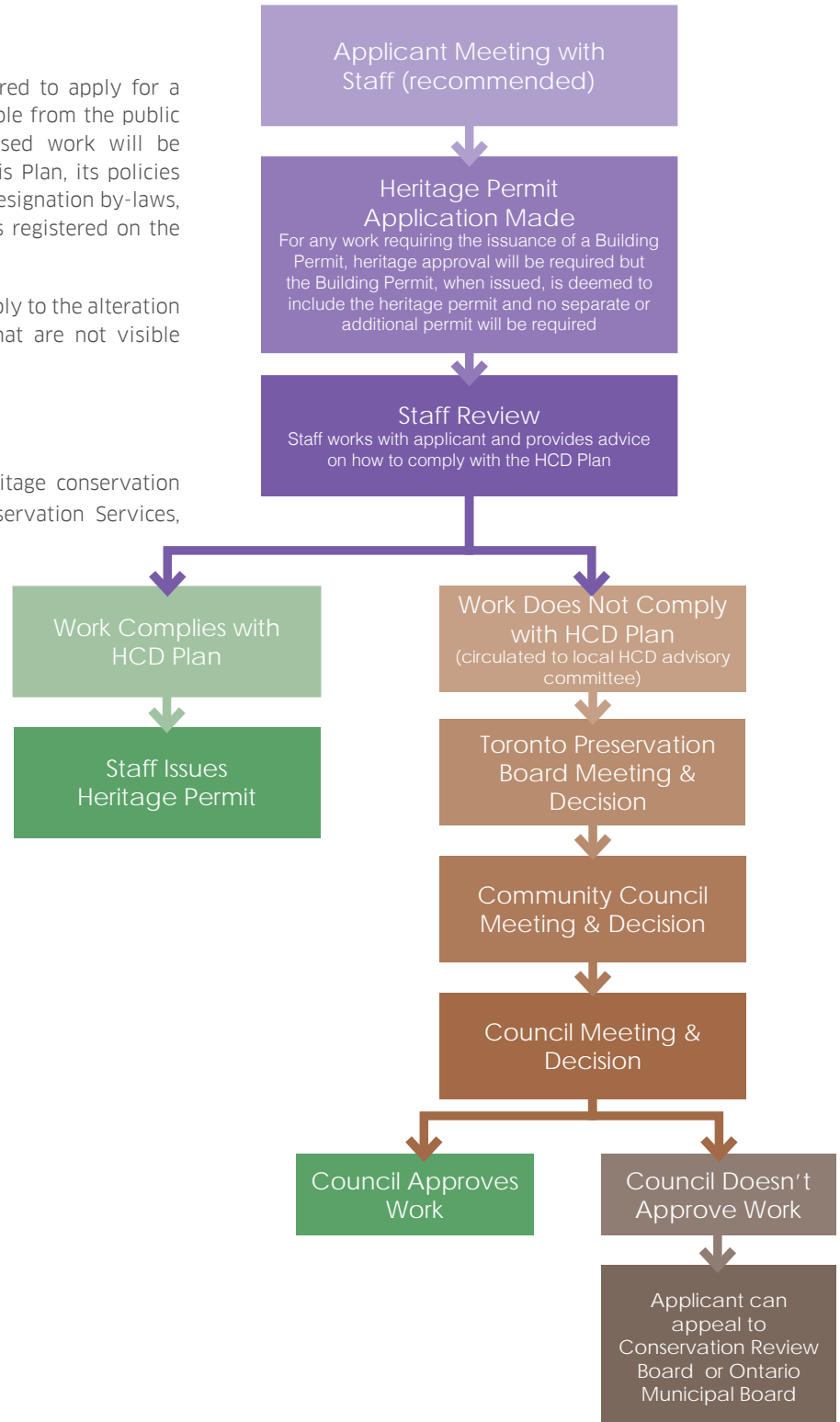

these include the Toronto Heritage Grant Program and the Property Tax Rebate Program. These two programs are updated from time to time, and up to date information is available through Heritage Preservation Services' website.

### 9.2.3 HERITAGE IMPACT ASSESSMENT

Heritage Impact Assessments (HIA) may be requested by municipal staff for development applications on or adjacent to properties that are on the City's Heritage Register. This work should be completed in accordance with the City's Terms of Reference for Heritage Impact Assessments.

An HIA is required for the following application types if the property is on the City's Heritage Register:

- Official Plan Amendment
- Zoning By-law Amendment
- Plans of Subdivision
- Site Plan Control

An HIA may be required for the following application types:

- Consent and/or Minor Variance and Building Permit applications for any property included on the City's Heritage Register.
- Where properties adjacent to a cultural heritage resource are subject to Official Plan Amendment, Zoning By-law Amendment, Plans of Subdivision, Site Plan Control and/or Consent and/or Minor Variance applications.
- Heritage Permit applications for any property designated under Part IV (individual) or Part V (Heritage Conservation District) of the Ontario Heritage Act.

### 9.2.4 HERITAGE INVESTIGATIONS

Over-clad buildings within HYHCD will require a Heritage Investigation. This work will assess the physical condition of the heritage building façade beneath the over-cladding adhered to a contributing property's façade. A Heritage Investigation may be required for the same application types as a Heritage Impact Assessment.

The scope of Heritage Investigations will be determined in coordination with municipal staff, but will at a minimum, require the following:

- Material Investigation:
  - A portion of the over-cladding material should be removed to reveal the building façade underneath. This work should be undertaken in the location of heritage attributes such as window openings, dormers, pilasters, and roof lines.
  - The method, material, or compound used to fasten the over-cladding to the building should be documented and investigated. This is critical to determining the preferred method for removing the over-cladding while minimizing damage to the historic fabric of the building.
  - The condition of the building's exterior walls, heritage attributes, and features should be investigated and documented.
- Historical Documentation:
  - Historical evidence of the building's condition at various points in its history may be collected at this time.
  - Documentation illustrating the original building design should also be gathered. This will inform the assessment of the building's current condition.

### 9.2.5 PLAN REVIEW AND UPDATES

This Plan should be reviewed and updated every 5-10 years. Failure to review the contents of the Plan within this review schedule will in no way invalidate the plan or its ability to be enforced. A preliminary review may be initiated by the City, who will initiate the review in coordination with the local HCD advisory committee. The preliminary review will consider all aspects of the Plan, including, but not limited to: its objectives, policies and guidelines, and schedule of contributing and non-contributing properties. If the preliminary review determines that changes to the Plan are required then an in-depth review will be completed to determine the specific nature and content of changes to the Plan. An outside consultant may be retained for the purposes of completing the intensive review.

Changes to this Plan must be carefully considered, and only undertaken in the spirit of conservation which informed its preparation. Where Council accepts recommended changes to the Plan it will do so through an amendment to this Plan and its by-law.

## 9.3 ADDITIONAL RECOMMENDATIONS

### 9.3.1 ZONING, BY-LAW, AND POLICY CHANGES

Properties within HYHCD are regulated under zoning *By-law 438-86*, and *By-law 569-2013*, which has been passed by Council but is currently under appeal to the Ontario Municipal Board. As well, there are a number of properties within HYHCD that are under site specific zoning provisions. No contradictions have been identified between the objectives and policies of this Plan and the existing zoning by-laws.

Site and Area Specific Policy (SASP) 382, adopted by Council through Official Plan Amendment (OPA) 183, as amended, includes a number of policies to manage change within the SASP 382 policy boundary, which overlap with HYHCD's boundary. Although OPA 183 has been appealed to the Board, there are differences between SASP 382 and this Plan that will need to be reconciled before, and if, SASP 382 comes into effect. The following policy sections of SASP 382 should be adjusted for consistency with this Plan, without limitation: 5.3.1, 5.3.3, 5.3.4, 5.3.6, 5.3.9, 5.8.3, 5.8.4, 5.8.5, and 5.8.6.

### 9.3.2 ADDITIONAL STUDIES

In the course of the study different areas of cultural heritage potential were identified. These areas may be warranted for further conservation efforts under the *Ontario Heritage Act*.

It is recommended the following areas be investigated for their cultural heritage value and further steps be taken to conserve those resources if warranted:

- The broader Yorkville area north and northwest of HYHCD.
- A pocket of semi- and single-detached residential homes between Gloucester and Dundonald Street, nearby HYHCD.

During the course of the project several stakeholders and participants in the process pointed to the character of fine-grain independent retail as a beloved aspect of HYHCD's character. This Plan guides the conservation of the physical fabric that is visible from the public realm and that has housed independent retailers. It does not, however, regulate the internal design of a building or retail space. Given the relationship between independent retail and Yonge Street, and the commercial aspect of Yonge Street's character, it is recommended the City investigate additional planning mechanisms to support fine grain independent retail, including, but not limited to, regulating the floor plate of retail spaces.

### 9.3.3 ADDITIONAL PART IV RECOMMENDATIONS

Within HYHCD there is one property that is not consistent with the cultural heritage value of HYHCD, but may warrant individual designation under Part IV of the *Ontario Heritage Act*. It is recommended the City consider designating 451-471 Yonge Street at the corner of Yonge Street and Carlton Street, in particular for its design value.

### 9.3.4 HERITAGE ADVISORY COMMITTEE

HCD Advisory Committees are an important part of successful HCDs. They can provide comments and feedback to Heritage Preservation Services staff regarding specific heritage permit applications within the HCD and may also be called on to provide feedback and comments on the implementation of the HCD Plan.

It is recommended that an Advisory Committee be created for the Historic Yonge Street HCD, and be comprised of local residents and property owners, members of the Bay-Cloverhill Residents Association, the Church Wellesley Neighbourhood Association and the Downtown Yonge BIA. The Advisory Committee will be formed in consultation with Heritage Preservation Services, and governed in accordance with the City's HCD Policies.

# BIBLIOGRAPHY

## City of Toronto

- 1986, Zoning By-law 438-86
- 2004, Bloor-Yorkville North Midtown Urban Design Guidelines
- 2006, Toronto Official Plan, as amended
- 2010, Area Specific Policy 211
- 2010, Area Specific Policy 225
- 2010, Heritage Impact Assessment Terms of Reference
- 2013, Area Specific Policy 382
- 2013, North Downtown Yonge Urban Design Guidelines
- 2013, Downtown Tall Buildings, Vision and Supplementary Design Guidelines
- 2013, Tall Building City-wide Design Guidelines
- 2013, Zoning By-law 569-2013
- 2015, St. Lawrence Neighbourhood HCD Plan

## Government of Ontario

- Ontario Heritage Act*, R.S.O. (1990), c. 0.18
- Ontario Planning Act*, R.S.O. (1990), c. P.13
- 2006, *Growth Plan for the Greater Golden Horseshoe*, Ministry of Public Infrastructure Renewal
- 2006, *Ontario Heritage Toolkit*, Ministry of Culture
- 2014, *Provincial Policy Statement*, Ministry of Municipal Affairs and Housing

Heritage Toronto, 1998, *The City of Toronto's Inventory of Heritage Properties*. Heritage Toronto, Toronto.

## McHugh, Patricia

- 1985, *Toronto Architecture: A city Guide*, Mercury Books, Toronto.

Parks Canada, 2010, *Standards & Guidelines for the Conservation of Historic Places in Canada*. 2nd Edition. Her Majesty the Queen in Right of Canada.



*This page left intentionally blank*



## APPENDIX A: DEFINITIONS

The following definitions have been prepared based on the definitions included in the City of Toronto Official Plan (section 3.1.5), The *Ontario Heritage Act*, and the *Standards and Guidelines for the Conservation of Historic Places in Canada*. Additional definitions have been provided where needed, based on the word's usage in this document.

**Additions:** New construction that extends the pre-existing building envelope in any direction, and which increases the building's pre-existing volume.

**Adjacent:** Means those lands adjoining a property on the Heritage Register or lands that are directly across from and near to a property on the Heritage Register and separated by land used as a private or public road, highway, street, lane, trail, right-of-way, walkway, green space, park and/or easement, or an intersection of any of these; whose location has the potential to have an impact on a property on the Heritage Register; or as otherwise defined in a Heritage Conservation District Plan adopted by by-law. (*Official Plan*)

**Alteration:** Means any change to a property on the Heritage Register in any manner including its restoration, renovation, repair or disturbance, or a change, demolition or removal of an adjacent property that may result in any change to a property on the Heritage Register. (*Official Plan*)

**Archaeological resources:** Artifacts, archaeological sites, and marine archaeological sites. The identification and evaluation of such resources are based upon archaeological field work undertaken in accordance with the Ontario Heritage Act.

**Archaeological site:** Any property that contains an artifact or any other physical evidence of past human activity that is of cultural heritage value or interest. Artifact means any object, material, or substance that is made, modified, used, deposited, or affected by human action and is of cultural heritage value.

**Areas of archaeological potential:** Areas with the likelihood to contain archaeological resources. Methods to identify archaeological potential are established by the Province, but municipal approaches which achieve the same objectives may also be used.

**Base building:** Refers to the portion of a building that either forms a podium for a tower, or is below the height at which stepbacks for tower developments are implemented.

**Building features:** Architectural details and components that make up a building's design and physical character. Building features include, but are not limited to: façade features, window features, and roof features, which also have their own constituent components that are defined in the relevant section of this Plan.

**Building:** An enclosed structure that is, or can be, used or occupied by people for a particular purpose.

**Compatibility:** In the context of this document refers to the physical and visual impacts of new development on existing structures and contributing properties. Physical compatibility refers to the use of materials and construction methods that do not negatively impact the contributing property, detract from or damage its heritage attributes. Visual compatibility refers to designing new work in such a way that it is distinguishable from the historic building, while complementing its design, massing, and proportions. (*Standards & Guidelines*)

**Conservation:** Means the identification, protection, management and use of built heritage resources, cultural heritage landscapes and archaeological resources in a manner that ensures their cultural heritage value or interest is retained under the *Ontario Heritage Act*. This may be achieved by the implementation of recommendations set out in a conservation plan, archaeological assessment and/or Heritage Impact Assessment. Mitigative measures and/or alternative development approaches can be included in these plans and assessments. Conservation and conserve have corresponding meanings. (*Official Plan*)

**Cultural Heritage Landscape:** A defined geographical area that may have been modified by human activity and is identified as having cultural heritage value or interest by a community, including an Aboriginal community. The area may involve features such as structures, spaces, archaeological sites or natural elements that are valued together for their interrelationship, meaning or association. Examples may include, but are not limited to, heritage conservation districts designated under the Ontario Heritage Act, villages, parks, gardens, battlefields, mainstreets and neighbourhoods, cemeteries, trailways, viewsheds, natural areas and industrial complexes of heritage significance, and areas recognized by federal or international designation authorities (e.g. a National Historic Site or District designation, or a UNESCO World Heritage Site). (*Official Plan*)

**Demolition:** The complete destruction of a heritage structure and property from its site, including the disassembly of structures and properties on the Heritage Register for the purpose of reassembly at a later date. (*Official Plan*)

**Heritage attributes:** In relation to real property, and to the buildings and structures on the real property, the attributes of the property, buildings and structures that contribute to their cultural heritage value or interest. (*Ontario Heritage Act*)

**Heritage Impact Assessment:** A document that provides relevant information on the nature and significance of a heritage property. It outlines the policy framework in which such properties can be conserved and identifies practical options to inform decisions and directions for the development of a conservation plan for the heritage resource. (Refer to Heritage Impact Statement (Conservation Strategy) Terms of Reference for more details). (*Building Toronto Together Terms of Reference*)

**Heritage Investigation:** A physical investigation, completed by or under the supervision of a qualified heritage professional, used to determine the integrity of a building's features that have been over-clad.

**Heritage Resource:** Includes properties, structures, buildings, and landscapes that display one or more of HYHCD's heritage attributes and contribute to its cultural heritage value.

**In-kind:** With the same form, material, and detailing as the existing. (*Standards & Guidelines*)

**Integrity:** As it relates to a heritage property or an archaeological site/resource, is a measure of its wholeness and intactness of the cultural heritage values and attributes. Examining the conditions of integrity requires assessing the extent to which the property includes all elements necessary to express its cultural heritage value; is of adequate size to ensure the complete representation of the features and processes that convey the property's significance; and the extent to which it suffers from adverse affects of development and/or neglect. Integrity should be assessed within a Heritage Impact Assessment.

**Maintenance:** Refers to preserving a building feature or element intact. It does not include restorative or repair work which requires a significant intervention and material change to the building feature or element.

**New Development:** Includes new construction on vacant lots, as well as new additions to existing buildings.

**Public Realm:** Any public space, including but not limited to: streets, sidewalks, laneways, parks, and privately owned publicly-accessible open spaces, walkways, or easements.

**Preservation:** The action or process of protecting, maintaining, and/or stabilizing the existing materials, form, and integrity of an historic place, or of an individual component, while protecting its heritage value. (*Standards & Guidelines*)

**Rehabilitation:** The action or process of making possible a continuing or compatible contemporary use of an historic place, or an individual component, while protecting its heritage value. (*Standards & Guidelines*)

**Removal:** Is the complete and permanent dislocation of a heritage resource from its site, including relocation of structures to another property. (*Official Plan*)

**Repair:** Refers to maintenance type work to a building element or feature that does not require a significant material change.

**Restoration:** The action or process of accurately revealing, recovering, or representing the state of an historic place, or of an individual component, as it appeared at a particular period in its history, while protecting its heritage value. (*Standards & Guidelines*)

**Scoped:** In the context of this plan refers to determining and refining the scope of work and investigation in a report. It is not used to refer to physical investigation of a building.

**Significant:** In regard to cultural heritage and archaeology, resources that have been determined to have cultural heritage value or interest for the important contribution they make to our understanding of the history of a place, an event, or a people.

**Street:** Refers to traffic lanes and sidewalks along a public right-of-way, as well as public laneways.

**Streetwall:** A characteristic of HYHCD's built form created by contiguous buildings built to the lot line and at a relatively consistent building height.

**Substantial:** In the context of conservation policies and guidelines, refers to conserving enough of a building that it will read as a three-dimensional free-standing building and not an foreign element attached to a new building or addition.



*This page left intentionally blank*

# B

## APPENDIX B: SCHEDULE OF CONTRIBUTING PROPERTIES

## Schedule of Contributing Properties

Address	Constructed	Architectural Character	Contribution to the District	Built Form	Storeys	Character Area
Breadalbane 7 (part of 526 528 Yonge)	1881	Retro-historic	Contextual Value	This is a coach house on the rear lot of a contributing Second Empire property. It is converted to a 2 storey stucco clad residence with a retro-classical appearance.	2	Historic Yonge Street
Charles West 5	1891	Romanesque	Design Value and Contextual Value	This property contains a 2.5 storey building clad in brick that has been painted. It is designed in a Romanesque style. It has a gable roof and dormer. It is within a row of five similar buildings.	2.5	Residential Pockets
Charles west 7	1891	Romanesque	Design Value and Contextual Value	This property contains a 2.5 storey building clad in brick that has been painted. It is designed in a Romanesque style. It has a gable roof and dormer. It is within a row of five similar buildings.	2.5	Residential Pockets
Charles west 9	1891	Romanesque	Design Value and Contextual Value	This property contains a 2.5 storey building clad in brick that has been painted. It is designed in a Romanesque style. It has a gable roof and dormer. It is within a row of five similar buildings.	2.5	Residential Pockets
Charles west 11	1891	Romanesque	Design Value and Contextual Value	This property contains a 2.5 storey building clad in brick that has been painted. It is designed in a Romanesque style. It has a gable roof and dormer. It is within a row of five similar buildings.	2.5	Residential Pockets
Charles west 13	1891	Romanesque	Design Value and Contextual Value	This property contains a 2.5 storey building clad in brick that has been painted. It is designed in a Romanesque style. It has a gable roof and dormer. It is within a row of five similar buildings.	2.5	Residential Pockets
College 14	1910	Edwardian Classical Revival	Design Value and Contextual Value	This is a two part building. The base building is a 2 storey, limestone Edwardian Beaux Arts Classical Revival building. It has a substantial entablature with projecting cornice, fine modillions, a plain frieze with two laurel wreath bosses at the end and a stepped architrave. The facade below is divided into three parts with a central recessed portico framed by two Ionic columns. The upper building, above the base building entablature, is a 4 storey, limestone-clad addition in a classical Art Deco Style. The facade follows the profile of the lower building. The recessed central bay has 4 window openings divided by tall receded pilasters terminating at simplified capitals below a simple, shallow, banded entablature.	5	College/Carlton

## Schedule of Contributing Properties

Address	Constructed	Architectural Character	Contribution to the District	Built Form	Storeys	Character Area
College 20	1956	Modern	Design Value and Contextual Value	This is a 2 storey, red brick building designed in a Modern style. It has a 3rd storey roof addition that steps back. The Base façade has a brick frame around a two storey glass wall with a large projecting canopy between ground and second fl. At the ground floor there is a multi panel storefront that opens to a small exterior seating terrace. At the third floor, the 2nd floor roof deck includes a perimeter railing an canopy structure. At the 4th floor the 3rd floor roof deck includes a second arched canopy structure. The heritage contribution of the building is primarily in the original base building.	4	College/Carlton
College 22	1910	Edwardian Classical Revival	Design Value and Contextual Value	This is a 5 storey brick and stone building in an Edwardian Classicism Style. At the roof line there is a plain moulded cornice. The attic storey is banded with plain recessed fillets. There are 5 rectangular window openings with tapered stone voussoirs and 3 keystone heads, 5 at the larger center window. In the middle section there is stone quoining at 4 corners, There are 5 windows per floor with flat stone lintels, toothed jamb stone trim and plain stone lug sills. At the second floor centre window there is an expressed bay, stepping forward with a curved architrave on a projecting cornice supported on 4 colonettes with windows set between. The ground floor 5 bay arcade is complex with a full entablature, projecting cornice, modillions, triglyph frieze and plan architrave supported on built up piers with Doric pilasters backing expressed 1/2 Doric columns. Between piers elliptical arches spring from the pilaster capitals.	2	College/Carlton
Gloucester 7	1886	Gothic Revival	Design and Contextual Value	This property contains a 2.5 storey building clad in red brick and constructed in a Gothic Revival Style. It has carved wood detailing around window openings and under the eaves of its roof lines. It is within a row of three similar buildings.	2.5	Residential Pockets
Gloucester 8 (12)	1868	Gothic Revival	Design and Contextual Value	This is a book-matched pair of semi-detached 2-1/2 storey Gothic Revival houses, with a sloped roofs and offset gables at the third floor. At the third floor a shingle sloped roof is interrupted by a large gable adorned with substantial decorative barge boards. Each side of the gable the roof is supported on decorative brackets. Window openings have segmental arched heads, corbeled brick drip hood moldings and lug sills.	2.5	Historic Yonge Street



## Schedule of Contributing Properties

Address	Constructed	Architectural Character	Contribution to the District	Built Form	Storeys	Character Area
Gloucester 9	1886	Gothic Revival	Design and Contextual Value	This property contains a 2.5 storey building clad in red brick and constructed in a Gothic Revival Style. It has carved wood detailing around window openings and under the eaves of its roof lines. It is within a row of three similar buildings.	2.5	Residential Pockets
Gloucester 11	1886	Gothic Revival	Design and Contextual Value	This property contains a 2.5 storey building clad in red brick and constructed in a Gothic Revival Style. It has carved wood detailing around window openings and under the eaves of its roof lines. It is within a row of three similar buildings.	2.5	Residential Pockets
Gloucester Lane 18	1912	Edwardian Industrial	Design and Contextual Value	This is a 5 storey buff brick building, designed in a simple utilitarian industrial style. On the principal (east) facade, there is regular arrangement of the segmental-arched entrances in the first floor, the segmental-arched window openings in the first through the fourth stories, and the flat-headed window openings in the attic level (which was an addition along with the penthouse). Semi-circular window openings have brick voussoirs, and all windows have plain lug sills.	5	Historic Yonge Street
Grenville 21	1872	Second Empire	Design Value and Contextual Value	This is a 2-1/2 storey polychromatic red-buff brick house in a Second Empire Style. The front facade is divided in a larger projecting bay with a projecting 2 storey bay window, left, and smaller entrance bay, right. A bell cast mansard roof follows the wall profile and is surmounted by a moulded cornice. Dormers have semi-circular roofs supported on brackets and semi-circular headed windows. The mansard has a projecting eave-gutter forming a small cornice supported on brackets. The brick wall has a red brick field with buff accents at corner quoins, roof hood mouldings and horizontal banding courses at the second and first floor lines. It was originally built for John Irwin, a local developer. It is incorporated as part of a modern condominium development.	2.5	Historic Yonge Street
Hayden 17	1886	Gothic Revival	Design Value and Contextual Value	This is a two storey building constructed in a gothic Revival style with pitched roofs, vertically oriented windows, and carved wood detailing below its eaves. It has brick cladding which is painted. It is setback from the property line.	2	Residential Pockets

## Schedule of Contributing Properties

Address	Constructed	Architectural Character	Contribution to the District	Built Form	Storeys	Character Area
Irwin 4	1904	Georgian	Design and Contextual Value	This is a 2 storey building of Georgian simplicity. It has a flat roof with shallow projecting fascia. At the second storey there are two window openings with shallow arched heads, brick voussoirs and rock faced stone lug sills.	2	Historic Yonge Street
Irwin 6	1893	Queen Anne	Design and Contextual Value	This 2-1/2 storey brick building is one unit in a 5 unit row house numbered 6,8,10,12,14 Irwin Ave designed in a Queen Anne Style. It has a sloped roof and central dormer with a tall pyramidal roof, an extension of a second floor bay window. The dormer is clad in scalloped wood shingles. Window and doors arches have tapered brick voussoirs and a drip trim course which extends across the wall to link arches in all units, with rock faced lug sills.	2.5	St. Nicholas Village
Irwin 7	1873	Georgian	Design and Contextual Value	This is a 2 storey building clad in brick with a gable roof sloped towards the street. It is a simply designed building that is representative of early housing in the district. It is set back from the lot line adjacent the street.	2	St. Nicholas Village
Irwin 8	1893	Queen Anne	Design and Contextual Value	This 2-1/2 storey brick building is one unit in a 5 unit row house numbered 6,8,10,12,14 Irwin Ave designed in a Queen Anne Style. It has a sloped roof and central dormer with a tall pyramidal roof, an extension of a second floor bay window. The dormer is clad in scalloped wood shingles. Window and doors arches have tapered brick voussoirs and a drip trim course which extends across the wall to link arches in all units, with rock faced lug sills.	2.5	St. Nicholas Village
Irwin 9	1873	Georgian	Design and Contextual Value	This is a 2 storey building clad in brick with a gable roof sloped towards the street. It is a simply designed building that is representative of early housing in the district. It is set back from the lot line adjacent the street.	2	St. Nicholas Village
Irwin 10	1893	Queen Anne	Design and Contextual Value	This 2-1/2 storey brick building is one unit in a 5 unit row house numbered 6,8,10,12,14 Irwin Ave designed in a Queen Anne Style. It has a sloped roof and central dormer with a tall pyramidal roof, an extension of a second floor bay window. The dormer is clad in scalloped wood shingles. Window and doors arches have tapered brick voussoirs and a drip trim course which extends across the wall to link arches in all units, with rock faced lug sills.	2.5	St. Nicholas Village

## Schedule of Contributing Properties

Address	Constructed	Architectural Character	Contribution to the District	Built Form	Storeys	Character Area
Irwin 11	1905	Queen Anne	Design and Contextual Value	11 and 13 Irwin are two semi-detached houses, that when read together display elements of the Queen Anne style. There is a small jerkin head peak as well at the top of the central gable.	2.5	St. Nicholas Village
Irwin 12	1893	Queen Anne	Design and Contextual Value	This 2-1/2 storey brick building is one unit in a 5 unit row house numbered 6,8,10,12,14 Irwin Ave designed in a Queen Anne Style. It has a sloped roof and central dormer with a tall pyramidal roof, an extension of a second floor bay window. The dormer is clad in scalloped wood shingles. Window and doors arches have tapered brick voussoirs and a drip trim course which extends across the wall to link arches in all units, with rock faced lug sills.	2.5	St. Nicholas Village
Irwin 13	1905	Queen Anne	Design and Contextual Value	11 and 13 Irwin are two semi-detached houses, that when read together display elements of the Queen Anne style. There is a small jerkin head peak as well at the top of the central gable.	2.5	St. Nicholas Village
Irwin 14	1893	Queen Anne	Design and Contextual Value	This 2-1/2 storey brick building is one unit in a 5 unit row house numbered 6,8,10,12,14 Irwin Ave designed in a Queen Anne Style. It has a sloped roof and central dormer with a tall pyramidal roof, an extension of a second floor bay window. The dormer is clad in scalloped wood shingles. Window and doors arches have tapered brick voussoirs and a drip trim course which extends across the wall to link arches in all units, with rock faced lug sills.	2.5	St. Nicholas Village
Irwin 17	1876	Georgian	Design and Contextual Value	This is a two storey building designed in a simple Georgian style with a gable roof. It is clad in yellow brick that is overgrown with vines. It is set back from the lot line.	2	St. Nicholas Village
Irwin 19	1876	Georgian	Design and Contextual Value	This is a two storey building designed in a simple Georgian style with a gable roof. It is over-clad with panels siding that appears to be vinyl. It is set back from the lot line.	2	St. Nicholas Village
Isabella 12	1910	Second Empire	Design Value and Contextual Value	This property contains a 2.5 storey building design in a second empire style and clad with polychromatic brick. It has decorative brickwork below its upper eaves, and separating the first and second storey. It is designed as a residential building.	2.5	Residential Pockets

## Schedule of Contributing Properties

Address	Constructed	Architectural Character	Contribution to the District	Built Form	Storeys	Character Area
St Joseph 5	1905	Renaissance Revival (Facade)	Design Value and Contextual Value	This is a Renaissance Revival warehouse. It is a 4 storey building had a flat roof with moulded stone fascia. The façade was divided into 3 receding vertical sections and the 4th floor was also divided horizontally by a brick/stone belt. Each section of the 4th floor had 3 rectangular windows with pointed tops, 5 rows of arched brick above, and a continuous stone sill. On the 3rd floor each section had 3 rectangular windows slightly arched, 5 rows of fanned vertical brick above, and a continuous stone sill. The same windows were found on the east and west sections of the 2nd floor, but with individual stone sills. In the middle section there was a large pointed window which formed part of the ground floor main entrance.	4	Historic Yonge Street
St Joseph 6	1879	Second Empire	Design and Contextual Value	This property is an excellent example of the Second Empire style, constructed at the peak of this style's popularity in Toronto. It is 2-1/2 storeys in height, clad in red brick with dichromatic stone masonry of tapered lintels above window and door openings. The mansard roof has an ornate eaves, below which is a decorated frieze of moulded brick with regularly spaced medallions, and carved brackets. It is part of a row of five buildings.	2.5	St. Nicholas Village
St Joseph 8	1879	Second Empire	Design and Contextual Value	This property is an excellent example of the Second Empire style, constructed at the peak of this style's popularity in Toronto. It is 2-1/2 storeys in height, clad in red brick with dichromatic stone masonry of tapered lintels above window and door openings. The mansard roof has an ornate eaves, below which is a decorated frieze of moulded brick with regularly spaced medallions, and carved brackets. It is part of a row of five buildings.	2.5	St. Nicholas Village
St Joseph 10	1879	Second Empire	Design and Contextual Value	This property is an excellent example of the Second Empire style, constructed at the peak of this style's popularity in Toronto. It is 2-1/2 storeys in height, clad in red brick with dichromatic stone masonry of tapered lintels above window and door openings. The mansard roof has an ornate eaves, below which is a decorated frieze of moulded brick with regularly spaced medallions, and carved brackets. It is part of a row of five buildings.	2.5	St. Nicholas Village

## Schedule of Contributing Properties

Address	Constructed	Architectural Character	Contribution to the District	Built Form	Storeys	Character Area
St Joseph 12	1879	Second Empire	Design and Contextual Value	This property is an excellent example of the Second Empire style, constructed at the peak of this style's popularity in Toronto. It is 2-1/2 storeys in height, clad in red brick with dichromatic stone masonry of tapered lintels above window and door openings. The mansard roof has an ornate eaves, below which is a decorated frieze of moulded brick with regularly spaced medallions, and carved brackets. It is part of a row of five buildings.	2.5	St. Nicholas Village
St Joseph 14	1879	Second Empire	Design and Contextual Value	This property is an excellent example of the Second Empire style, constructed at the peak of this style's popularity in Toronto. It is 2-1/2 storeys in height, clad in red brick with dichromatic stone masonry of tapered lintels above window and door openings. The mansard roof has an ornate eaves, below which is a decorated frieze of moulded brick with regularly spaced medallions, and carved brackets. It is part of a row of five buildings.	2.5	St. Nicholas Village
St Joseph 16 21	1926	Edwardian Classical Revival	Design and Contextual Value	This is a 4 storey brick building with stone accents in an Edwardian Classicism Style. There is a simplified entablature at the roof with a projecting cornice, brackets and plain frieze, and a flat architrave in patterned brick and stone. There is a banding course at the 2nd and 4th floor levels. The facade is symmetrically organized into three bays with the central bay projecting. On the central axis, windows are raised to half landing and half down is the main entrance door .	3	Historic Yonge Street
St Joseph 20	1892	Queen Anne	Design and Contextual Value	This is a 2-1/2 storey brick and stone in a high Queen Anne Style. It has a complex gable ended and cross sloped roof and a corner tower with a conical roof. The gable end is clad in red tiles and includes a large grouped window opening with bracketed eyebrow roofette. The Tower, below the conical roof has a round tile clad wall with three separate windows and below that a sloping skirt forming a shallow eave condition. The tower has three windows with rock faced stone lintels and continuous stone sills forming a band course.	2.5	St. Nicholas Village

## Schedule of Contributing Properties

Address	Constructed	Architectural Character	Contribution to the District	Built Form	Storeys	Character Area
St Joseph 22	1892	Queen Anne	Design and Contextual Value	This is a 2-1/2 story building in a Queen Anne Style with a part exposed basement to form a parking pad. It has a gable ended roof with decorative barge boards on a projecting eave and wood shingle clad wall which terminates at a projecting moulded entablature supported at the small bay on a bracket. It has a 3 part grouped central window with small eyebrow roofette. At the second floor large bay, a pair of centred windows with flat stone segmental arch drip hood lintels and plain lug sills.	2.5	St. Nicholas Village
St Joseph 26	1940	Art Deco	Design and Contextual Value	This is a 6 storey building designed in an Art Deco style with buff brick. its main entrance is framed by sidelights and flat headed windows on concrete sills. The ground storey is separated from the upper storeys by a continuous concrete stringcourse. The upper storeys are highlighted by a continuous concrete vertical frontispiece which rises to the sixth storey. It is detailed with glass block decorative brick bands and a concrete cornice, reflective of the Art Deco style.	6	Residential Pockets
St Mary 10	1957	Mid Century Modern	Design Value and Contextual Value	This is a 8 storey building designed in a mid-century modern architectural style. Its façade follows a grid like organization created by brick and painted concrete.	8	Historic Yonge Street
St Nicholas 45 47	1884	Gothic Revival	Design and Contextual Value	This is a two storey building designed in Gothic Revival style and clad in brick. It has a gable roof and a decorative wood verge board. It is part of a row of cottages that are each named after different trees.	2	St. Nicholas Village
St Nicholas 49	1884	Gothic Revival	Design and Contextual Value	This is a two storey building designed in Gothic Revival style and clad in brick. It has a gable roof and a decorative wood verge board. It is part of a row of cottages that are each named after different trees.	2	St. Nicholas Village
St Nicholas 5	1903	Edwardian Commercial	Design Value and Contextual Value	This is a 2 storey brick building, designed with simple architectural details. It has a flat roof with a false front and corbelling. The facade and side of the front third has been trimmed in brown wood. There are 2 square windows on the upper floor facade, both with stained glass and trimmed in brown wood.	2	Historic Yonge Street

## Schedule of Contributing Properties

Address	Constructed	Architectural Character	Contribution to the District	Built Form	Storeys	Character Area
St Nicholas 9	1913	Edwardian Commercial	Design Value and Contextual Value	This is a 6 storey brick warehouse. It has a flat roof, with a stepped parapet at the rear and chimney on the south wall. It is a rectangular building with a narrow end wall forming the west facade on St. Nicholas. The west facade is red brick while the other walls are brown/yellow brick. The west facade has 2 windows per floor. Windows are semi-elliptical. The ones on the right side have a fixed pane while the ones on the left have a bottom slider. Each window has 3 rows of brick voussoirs and a plain stone sill. The south wall, 6th floor has been painted with a large rectangular "M. Rawlinson Limited" sign and a large square "Moving/Packing/Storage" sign.	6	Historic Yonge Street
St Nicholas 51	1884	Gothic Revival	Design and Contextual Value	This is a two storey building designed in Gothic Revival style and clad in brick. It has a gable roof and a decorative wood verge board. It is part of a row of cottages that are each named after different trees.	2	St. Nicholas Village
St Nicholas 53	1884	Gothic Revival	Design and Contextual Value	This is a two storey building designed in Gothic Revival style and clad in brick. It has a gable roof and a decorative wood verge board. It is part of a row of cottages that are each named after different trees.	2	St. Nicholas Village
St Nicholas 55	1884	Gothic Revival	Design and Contextual Value	This is a two storey building designed in Gothic Revival style and clad in brick. It has a gable roof and a decorative wood verge board. It is part of a row of cottages that are each named after different trees.	2	St. Nicholas Village
St Nicholas 57	1884	Gothic Revival	Design and Contextual Value	This is a two storey building designed in Gothic Revival style and clad in brick. It has a gable roof and a decorative wood verge board. It is part of a row of cottages that are each named after different trees.	2	St. Nicholas Village
St Nicholas 59	1884	Gothic Revival	Design and Contextual Value	This is a two storey building designed in Gothic Revival style and clad in brick. It has a gable roof and a decorative wood verge board. It is part of a row of cottages that are each named after different trees.	2	St. Nicholas Village
St Nicholas 61	1884	Gothic Revival	Design and Contextual Value	This is a two storey building designed in Gothic Revival style and clad in brick. It has a gable roof and a decorative wood verge board. It is part of a row of cottages that are each named after different trees.	2	St. Nicholas Village
St Nicholas 63	1884	Gothic Revival	Design and Contextual Value	This is a two storey building designed in Gothic Revival style and clad in brick. It has a gable roof and a decorative wood verge board. It is part of a row of cottages that are each named after different trees.	2	St. Nicholas Village

## Schedule of Contributing Properties

Address	Constructed	Architectural Character	Contribution to the District	Built Form	Storeys	Character Area
St Nicholas 79	1930	Edwardian Commercial	Contextual Value	This property contains a 1 storey addition to an adjacent warehouse. It has red brick cladding and a recessed entrance.	1	Historic Yonge Street
St Nicholas 81	1912	Romanesque	Design Value and Contextual Value	This is a 2 storey commercial warehouse building constructed in a Romanesque style. It has polychromatic decorative brickwork at the roof line; semi-circular vertically oriented windows, and a recessed entrance with an arched entryway.	2	Historic Yonge Street
St Nicholas 85	1912	Romanesque	Design Value and Contextual Value	This is a 2 storey commercial warehouse building constructed in a Romanesque style. It has polychromatic decorative brickwork at the roof line; semi-circular vertically oriented windows, and a recessed entrance with an arched entryway.	2	Historic Yonge Street
Wellesley 10 12 14 16	1876	Over-clad (second empire)	Contextual Value	This is a four unit building designed in a Second Empire style. It has been over-clad, obscuring its architectural features.	2.5	Historic Yonge Street
Yonge 450	1891	Gothic Revival/Chateau	Design Value and Contextual Value	This is a 4 storey building designed with Gothic Revival and Chateau elements, including: towers, gables and stone detail; dormers and roof shapes associated with "Chateau" designs. 2 octagonal towers face Yonge St have pierced parapets and narrow vertical window openings at upper level; a continuous painted sign band separates the first and second storeys and continues along the College St. elevation. The Yonge St. entrance, altered in 1931, has an arched pediment & tripartite fanlight with grillwork. On the College St. side, there is a series of gabled dormers, at the west end a square tower with hipped roof and a Flemish wall dormer containing a double window with tracery and a blind fanlight with carving. A second Flemish wall dormer has paired window openings within a stone ogee arch. The College St. entrance is recessed in a round arched opening, double wood doors, a fan transom and stone detailing.	4	College/Carlton



## Schedule of Contributing Properties

Address	Constructed	Architectural Character	Contribution to the District	Built Form	Storeys	Character Area
Yonge 480 482	1864	Italianate	Design Value and Contextual Value	This is a three storey building designed in a Italianate style. Its brick cladding has been covered on the second and third floors with stucco or plaster. Italianate details such as stone quoins and window surrounds remain, and in a contrasting colour. There is a missing or altered cornice at the top, cornice brackets have survived, interrupted in the centre by a slightly raised parapet-like structure. There were originally three windows on each of the upper floors. The central window on the third floor was walled up, but the flat top projecting surround remains. Second floor windows have semicircular surrounds with molded keystones and blind shaped transoms.	3	Historic Yonge Street
Yonge 484	1956	Clock tower (classical revival); base building (contemporary retro-historic)	Design Value and Contextual Value	The base building on this property has been renovated and retro-fitted several times in its history. It incorporates a fire hall clock tower though which is a landmark within HYHCD. The clock tower and its adjoining fire hall (now demolished) were built in 1872. The clock tower is the main contribution to the district's heritage character.	2	Historic Yonge Street
Yonge 490	1916	Modern (early)	Design Value and Contextual Value	This is a 2 storey building in a early Modern style. The upper level has a large segmented shallow "bay" 5 panel window, with the end panels recessed, extending the width of the store. Narrow vertical wall sections framing the storefront are covered with tiles. A flat, painted horizontal panel runs across the width of the top of the facade, possibly covering a canopy-like element that was originally above the windows - visible in the 1952 photographs.	2	Historic Yonge Street

## Schedule of Contributing Properties

Address	Constructed	Architectural Character	Contribution to the District	Built Form	Stores	Character Area
Yonge 496 498	1886	Second Empire	Design Value and Contextual Value	<p>This building is a good example of late 19th century Second Empire styling that was updated with complementary Classical embellishments in the 20th century. Constructed of brick and trimmed with brick, stone and wood, the three-storey building features a rectangular plan. The mansard roof has slate cladding, four brick chimneys, a cornice with dentils, and four pedimented wall dormers with round-arched window openings and Classical detailing. The first storey is faced with limestone. The bank entrance, placed on the Yonge Street facade, features a pedimented stone door case and a metal transom. The stone pilasters that organize the flat-headed window openings in the first floor are continued in brick through the second storey where pairs of recessed round-arched window openings have Classical detailing. The corner tower with a hip roof is a distinctive feature.</p>	2.5	Historic Yonge Street
Yonge 502A 504	1862	Renaissance Revival	Design Value and Contextual Value	<p>This is a pair of 3 storey painted brick Renaissance Revival buildings. The façade is a grid of rectangular window openings on a plain brick field over a ground floor with a pair of shop fronts. Four window openings at the second floor have flat roofettes on brackets with corbelled brick between and plain lug sills. Four window openings at the third floor have pedimented roof hoods on brackets with corbelled brick between and plain lug sills. At the second floor line is a projecting cornice sign band framed by brick brackets. Ground floor storefront is recent, a large display window rolls sideways to open the entire front, there is a recessed entrance and door to right and single door to upper floor.</p>	3	Historic Yonge Street

## Schedule of Contributing Properties

Address	Constructed	Architectural Character	Contribution to the District	Built Form	Storeys	Character Area
Yonge 506	1862	Renaissance Revival	Design Value and Contextual Value	This is one of a pair of 3 storey painted brick Renaissance Revival buildings. The façade is a grid of rectangular window openings on a plain brick field over a ground floor with a pair of shop fronts. Two window openings at the third floor have flat roofettes on brackets with corbelled brick between and plain lug sills. Two window openings at the second floor have pedimented roof hoods on brackets with corbelled brick between and plain lug sills. At the second floor line is a projecting cornice sign band framed by brick brackets. Ground floor storefront is recent, a large display window rolls sideways to open the entire front, there is a recessed entrance and door to right and single door to upper floor.	3	Historic Yonge Street
Yonge 508	1862	Renaissance Revival	Design Value and Contextual Value	This is one of a pair of 3 storey painted brick Renaissance Revival buildings. The façade is a grid of rectangular window openings on a plain brick field over a ground floor with a pair of shop fronts. Two window openings at the third floor have flat roofettes on brackets with corbelled brick between and plain lug sills. Two window openings at the second floor have pedimented roof hoods on brackets with corbelled brick between and plain lug sills. At the second floor line is a projecting cornice sign band framed by brick brackets. Ground floor storefront is recent, a large display window rolls sideways to open the entire front, there is a recessed entrance and door to right and single door to upper floor.	3	Historic Yonge Street
Yonge 514 516	1877	Over-clad	Contextual Value	This building has been over-clad obscuring its features. Historic pictures indicate it was designed in a predominantly Second Empire style.	2.5	Historic Yonge Street

## Schedule of Contributing Properties

Address	Constructed	Architectural Character	Contribution to the District	Built Form	Storeys	Character Area
Yonge 522	1918	Edwardian	Contextual Value	This is a 2 storey building that has undergone renovations and originally designed in an Edwardian style. An arched parapet with shallow cornice trim frames a blank oval cartouche. The second floor has a symmetrical group of three double recessed windows with a continuous sill. A shallow trim cornice separated the ground floor. A blank wall has wall signs mounted above contemporary offset storefronts with, right a small recessed entrance to the upper floors . Storefronts are book-matched, display windows on tiled curb walls are separated by a recessed double entrance and doors to each unit.	2	Historic Yonge Street
Yonge 526 528 (7 Breadalbane)	1881	Second Empire	Design Value and Contextual Value	This is a 2-1/2 storey painted brick and stone building in a high Second Empire style. The mansard roof is framed by end parapet firewalls and capped by projecting cornice. It terminates at a projecting cornice-gutter/entablature on brackets. The facade is symmetrically arranged in 3 bays separated by pilasters, with a larger more decorative central bay. At the mansard two smaller dormers flank a larger central dormer with a square tower roof capped by projecting cornice. Small dormers have shed roofs on brackets, wood trim and lintels frame the window openings. A second floor entablature spans the building divided by large decorative brackets at each pilaster and includes, projecting cornice, a bracketed frieze on corbelled brick and plain band architrave/continuous window lintel.	2.5	Historic Yonge Street
Yonge 527 Maitland 2 4 6	1876	Second Empire	Design Value and Contextual Value	This is a 2.5 storey building designed in a Second Empire Style. It is clad in brick that has been painted. It has a mansard roof with three dormers with moulded eaves. Window openings have Italianate style lintels with decorated keystones and voussoirs.	2.5	Historic Yonge Street
Yonge 529	1876	Second Empire	Design Value and Contextual Value	This is a 2.5 storey building designed in a Second Empire Style. It is clad in brick that has been painted. It has a mansard roof with three dormers with moulded eaves. There is a dentil frieze below the mansard and framing a projecting eaves and brick corbeling. Window openings are rectangular, with a large central bay window.	3	Historic Yonge Street

## Schedule of Contributing Properties

Address	Constructed	Architectural Character	Contribution to the District	Built Form	Storeys	Character Area
Yonge 531	1883	Italianate	Design Value and Contextual Value	This is a 3 storey Italianate Style building in red brick. 3 vertical pilasters divide the facade, and terminate at the roof in large expressive capitals. The building is capped with a deep painted entablature with mouldings and semicircular half medallions above corbelled brick brackets. Window openings have expressed relieving arches and wide continuous stone lintels above paired windows, one arch per window at the third floor and paired at the second floor. Between arch and lintel are tapered brick voussoirs.	3	Historic Yonge Street
Yonge 533	1880	Second Empire	Design Value and Contextual Value	This is a 2.5 storey building designed in a Second Empire style with elements of Italianate and Queen Anne as well. It has a mansard roof with three dormers. It is clad in brick with dichromatic stone work in the form of continuous decorated lintels.	3	Historic Yonge Street
Yonge 530, 536	1948	Modern	Contextual Value	This is a 2 storey commercial building designed in a modern style. Its windows are grouped in a ABA pattern with a large central ribbon. It has a main recessed corner entrance. The façade has some out-sulation applied, which appears to be added to the original facade cladding of red brick.	2	Historic Yonge Street
Yonge 535	1881	Italianate	Design Value and Contextual Value	This is a 3 storey building designed in an Italianate style. It is clad in brick that has been painted black. Originally it was likely designed to resemble 531 Yonge Street. Window openings have expressed relieving arches and wide continuous stone lintels above paired windows, one arch per window at the third floor and paired at the second floor. Between arch and lintel are tapered brick voussoirs. Upper windows have stone lug sills. The storefront sits on a slightly raised moulded wood and masonry base.	3	Historic Yonge Street
Yonge 538	1873	Second Empire	Design Value and Contextual Value	This is a 2.5 storey brick building in a Second Empire Style. It is part of a row divided into pairs of units by projecting fire walls (3 in total). The slate-tiled mansard roof is capped by a substantial moulded cornice and ends at a projecting cornice/gutter. There is one central dormer in each unit with 1/2 round projecting roof supported on brackets and trim that frame the 1/2 round window opening. The cornice is supported on 3 brackets joined by a banding course.	2.5	Historic Yonge Street

## Schedule of Contributing Properties

Address	Constructed	Architectural Character	Contribution to the District	Built Form	Storeys	Character Area
Yonge 540	1873	Second Empire	Design Value and Contextual Value	This is a 2.5 storey brick building in a Second Empire Style. It is part of a row divided into pairs of units by projecting fire walls (3 in total). The slate-tiled mansard roof is capped by a substantial moulded cornice and ends at a projecting cornice/gutter. There is one central dormer in each unit with 1/2 round projecting roof supported on brackets and trim that frame the 1/2 round window opening. The cornice is supported on 3 brackets joined by a banding course.	2.5	Historic Yonge Street
Yonge 542	1873	Second Empire	Design Value and Contextual Value	This is a 2.5 storey brick building in a Second Empire Style. It is part of a row divided into pairs of units by projecting fire walls (3 in total). The slate-tiled mansard roof is capped by a substantial moulded cornice and ends at a projecting cornice/gutter. There is one central dormer in each unit with 1/2 round projecting roof supported on brackets and trim that frame the 1/2 round window opening. The cornice is supported on 3 brackets joined by a banding course.	2.5	Historic Yonge Street
Yonge 544	1873	Second Empire	Design Value and Contextual Value	This is a 2.5 storey brick building in a Second Empire Style. It is part of a row divided into pairs of units by projecting fire walls (3 in total). The slate-tiled mansard roof is capped by a substantial moulded cornice and ends at a projecting cornice/gutter. There is one central dormer in each unit with 1/2 round projecting roof supported on brackets and trim that frame the 1/2 round window opening. The cornice is supported on 3 brackets joined by a banding course.	2.5	Historic Yonge Street
Yonge 546	1889	Romanesque	Design Value and Contextual Value	This is a 3 storey building, part of a block of 3 units designed in a Romanesque style. Units are framed by projecting pilasters at the party walls with corbelled brick capitals at the 3rd floor window line. At the roof it is likely there was a projecting cornice, now missing. Below the parapet is a projecting cornice carried on bracketed keystones of the two-3rd floor windows. Third floor windows have semi-circular arched heads springing from stone flat lintels. The panel above is a basket weave brick and below the lintel a large rectangular window opening. At the second floor there are two matching windows but with segmented arched heads and plain panels. The window sills are continuous, forming a band course.	3	Historic Yonge Street

## Schedule of Contributing Properties

Address	Constructed	Architectural Character	Contribution to the District	Built Form	Storeys	Character Area
Yonge 548	1889	Romanesque	Design Value and Contextual Value	This is a 3 storey building, part of a block of 3 units designed in a Romanesque style. Units are framed by projecting pilasters at the party walls with corbelled brick capitals at the 3rd floor window line. At the roof it is likely there was a projecting cornice, now missing. Below the parapet is a projecting cornice carried on bracketed keystones of the two-3rd floor windows. Third floor windows have a semi-circular arched head, with a decorative terracotta panel below the sill. The panel above is a basket weave brick and below the lintel a large rectangular window opening. At the second floor there are two matching windows but with segmented arched heads and plain panels. The window sills are continuous, forming a band course.	3	Historic Yonge Street
Yonge 550	1889	Romanesque	Design Value and Contextual Value	This is a 3 storey building, part of a block of 3 units designed in a Romanesque style. Units are framed by projecting pilasters at the party walls with corbelled brick capitals at the 3rd floor window line. At the roof it is likely there was a projecting cornice, now missing. Below the parapet is a projecting cornice carried on bracketed keystones of the two-3rd floor windows. Third floor windows have semi-circular arched heads springing from stone flat lintels. The panel above is a basket weave brick and below the lintel a large rectangular window opening. At the second floor there are two matching windows but with segmented arched heads and plain panels. The window sills are continuous, forming a band course.	3	Historic Yonge Street
Yonge 552 554	1912	Edwardian	Design Value and Contextual Value	This is a 3 storey orange-brown mottled brick building in a simple, commercial Edwardian Style. A roof cornice at the top of the wall is missing and covered by metal siding. The façade is divided into two bays by a brick frame around a group of 4 recessed windows at second and third floors. The frame is gridded at the top of the wall by lines extending vertically and horizontally above the third floor windows. Each group of 4 window openings is divided vertically into two vertical groups of 2 with stepped brick on each side creating a brick pilaster between. Window openings have plain stone lintels and sills.	3	Historic Yonge Street

## Schedule of Contributing Properties

Address	Constructed	Architectural Character	Contribution to the District	Built Form	Storeys	Character Area
Yonge 556	1879	Over-clad	Contextual Value	This is a three storey building that has been over-clad with paneled metal siding, obscuring its architectural features	3	Historic Yonge Street
Yonge 564	1874	Georgian	Design Value and Contextual Value	This is a 2.5 storey building built in a Georgian Style. It has a sloping roof with dormers. A projecting roof eave sits on a 3 course corbelled brick fascia. At each end of the group of 3 units there is a projecting parapet firewall. Each unit is separated by chimney masses at the ridge and is separated by wall brick quoining. Second floor windows have brick drip hood mouldings with a linking horizontal band course at the drip and plain lug sills.	2.5	Historic Yonge Street
Yonge 565	1889	Richardsonian Romanesque	Design Value and Contextual Value	This is a 4 storey building designed in a Richardsonian Romanesque style. It is part of a 4 bay building. Each bay is framed by pilasters which rise off the commercial base and terminate in the 3rd storey at large arches spanning punched windows. Window sills and lintels vary between floor to include continuous and lug styles using rock and smooth faces. The spandrel between 2nd and 3rd floors features a checkerboard of rock faced stone and brick panels, At the 4th floor, attic storey, there are 3 grouped windows divided by brick piers, with similar continuous bands of sills and window lintels above which support a projecting cornice including large rock faced stone brackets.	4	Historic Yonge Street
Yonge 566	1873	Georgian	Design Value and Contextual Value	This is a 2.5 storey building built in a Georgian Style. It has a sloping roof with dormers. A projecting roof eave sits on a 3 course corbelled brick fascia. At each end of the group of 3 units there is a projecting parapet firewall. Each unit is separated by chimney masses at the ridge and is separated by wall brick quoining. Second floor windows have brick drip hood mouldings with a linking horizontal band course at the drip and plain lug sills.	2.5	Historic Yonge Street



## Schedule of Contributing Properties

Address	Constructed	Architectural Character	Contribution to the District	Built Form	Storeys	Character Area
Yonge 567	1889	Richardsonian Romanesque	Design Value and Contextual Value	This is a 4 storey building designed in a Richardsonian-Romanesque style. It is part of a 4 bay building. Each bay is framed by pilasters which rise off the commercial base and terminate in the 3rd storey at large arches spanning punched windows. Window sills and lintels vary between floor to include continuous and lug styles using rock and smooth faces. The spandrel between 2nd and 3rd floors features a checkerboard of rock faced stone and brick panels, At the 4th floor, attic storey, there are 3 grouped windows divided by brick piers, with similar continuous bands of sills and window lintels above which support a projecting cornice including large rock faced stone brackets.	4	Historic Yonge Street
Yonge 568	1873	Georgian	Design Value and Contextual Value	This is a 2.5 storey building built in a Georgian Style. It has a sloping roof with dormers. A projecting roof eave sits on a 3 course corbelled brick fascia. At each end of the group of 3 units there is a projecting parapet firewall. Each unit is separated by chimney masses at the ridge and is separated by wall brick quoining. Second floor windows have brick drip hood mouldings with a linking horizontal band course at the drip and plain lug sills.	2.5	Historic Yonge Street
Yonge 569	1889	Richardsonian Romanesque	Design Value and Contextual Value	This is a 4 storey building designed in a Richardsonian Romanesque style. It is part of a 4 bay building. Each bay is framed by pilasters which rise off the commercial base and terminate in the 3rd storey at large arches spanning punched windows. Window sills and lintels vary between floor to include continuous and lug styles using rock and smooth faces. The spandrel between 2nd and 3rd floors features a checkerboard of rock faced stone and brick panels, At the 4th floor, attic storey, there are 3 grouped windows divided by brick piers, with similar continuous bands of sills and window lintels above which support a projecting cornice including large rock faced stone brackets.	4	Historic Yonge Street

## Schedule of Contributing Properties

Address	Constructed	Architectural Character	Contribution to the District	Built Form	Storeys	Character Area
Yonge 570 572	1876	Second Empire	Contextual Value	This is a 2.5 storey building designed in a Second Empire style. It is part of a row of similarly designed units. It has a mansard roof, and originally would have had bell cast dormers. It is clad in red brick with poly-chromatic brickwork. The roof has projecting eaves, under which is a simple cornice moulding, brackets and fascia of red and buff brick panels between brackets. Window openings have segmented arched heads with limestone keystone and tapered voussoirs in double rows of alternating brick.	2.5	Historic Yonge Street
Yonge 571	1889	Richardsonian Romanesque	Design Value and Contextual Value	This is a 4 storey building designed in a Richardsonian Romanesque style. It is part of a 4 bay building. Each bay is framed by pilasters which rise off the commercial base and terminate in the 3rd storey at large arches spanning punched windows. Window sills and lintels vary between floor to include continuous and lug styles using rock and smooth faces. The spandrel between 2nd and 3rd floors features a checkerboard of rock faced stone and brick panels, At the 4th floor, attic storey, there are 3 grouped windows divided by brick piers, with similar continuous bands of sills and window lintels above which support a projecting cornice including large rock faced stone brackets.	4	Historic Yonge Street
Yonge 573 575	1895	Early Modern (Chicago School)	Design Value and Contextual Value	This is a early modern style building designed with minimal features. There is plain metal flashing at the roof. At the second storey there are 4 wide window openings with glass and metal windows 1/4-paired horizontal sliders. Below the windows is a row of square recesses 1 brick apart forming a decorative band.	2	Historic Yonge Street
Yonge 574	1890	Early Modern	Contextual Value	This was originally a 3 storey Second Empire building but was rebuilt in 1890 in a more modern style with a flat roof and buff brick facade. A plain brick pilaster extends from the roof line to the 2nd floor on the south edge. There is a large plate glass window on the ground floor and it and the entrance on the right to the restaurant are recessed.	3	Historic Yonge Street

## Schedule of Contributing Properties

Address	Constructed	Architectural Character	Contribution to the District	Built Form	Stores	Character Area
Yonge 576	1876	Second Empire	Design Value and Contextual Value	This is a 2.5 storey building designed in a Second Empire style. It is part of a row of similarly designed units. It has a mansard roof, and originally would have had bell cast dormers. It is clad in brick with poly-chromatic brickwork that has been painted over. The roof has projecting eaves, under which is a simple cornice moulding, brackets and fascia of redbrick and buff brick panels between brackets. Window opening have segmented arched heads with limestone keystone.	2.5	Historic Yonge Street
Yonge 577	1899	Edwardian Classical	Design Value and Contextual Value	This is a four storey, 3 bay, brick building designed in a Edwardian style. The lower 3 stories are sharply divided into three bays by simple pilaster/ piers. At the 4th floor the building steps back to create an "attic" story. The center bay is flanked on each side by bays with large, 3 panel, bay windows at the 2nd and 3rd floors. The north and south piers project out further about one foot and are each topped by a round sphere. The 4th floor attic story has 6 evenly spaced 1/1 windows above which is a simple projecting eave and parapet. The brick façade has been painted white and the south, north and rear walls are painted black. Paint has peeled from the side wall to reveal the original brick colour as orange /red.	4	Historic Yonge Street
Yonge 578 580	1890	Renaissance Revival	Design Value and Contextual Value	This is a 3 storey brown brick building in a late Victorian Renaissance Revival Style. The elevation is symmetrical and divided into two bays by shallow pilasters. The roof parapet has a curved form with corner pedestals and a central arched pediment. At the roof line there is an entablature with a projecting cornice supported on brackets and a plain frieze. At the third floor, inset between pilasters, are 2 paired windows per bay (total 4) each with segmental arched heads, brick voussoirs and expressed stone keystone. Stone sills extend across each pair. At the second floor between pilasters is 1 large bay window per bay (total 2). Windows are surmounted by moulded projecting cornice and roofette and sit upon a paneled wood knee wall. The Bay windows and pilasters sit on a projecting cornice sign band at the second floor line.	3	Historic Yonge Street

## Schedule of Contributing Properties

Address	Constructed	Architectural Character	Contribution to the District	Built Form	Storeys	Character Area
Yonge 579	1951	Art Moderne	Design Value and Contextual Value	This is a 2 storey building designed in an Art Moderne style. It is streamlined style with a curved element at the north corner of the front façade where the main entrance door is located. It has continuous bands of brick or stone at the roof parapet, second floor window lintels, second floor window sill and a thin canopy above the corner entrance extending south on Yonge.	2	Historic Yonge Street
Yonge 582	1876	Second Empire	Design Value and Contextual Value	This building is a unit of a row of eight 2.5 storey, polychromatic brick shops in a Second Empire Style. It has a bell-cast mansard roof with central dormer. The dormer has a semi-circular roof over a bracketed wood framed window opening with a semi-circular head. The roof, clad with black shingles, has projecting eaves. Under the eaves there is a simple cornice moulding, brackets, and a fascia of painted brick with brick panels between the brackets.	2.5	Historic Yonge Street
Yonge 584	1876	Second Empire	Design Value and Contextual Value	This building is a unit of a row of eight 2.5 storey, polychromatic brick shop-houses in a Second Empire Style. It has a bell-cast mansard roof with central dormer. The dormer has a semi-circular roof over a bracketed wood framed window opening with a semi-circular head. The roof, clad with black shingles, has projecting eaves. Under the eaves there is a simple cornice moulding, brackets, and a fascia of painted brick with brick panels between the brackets.	2.5	Historic Yonge Street
Yonge 586	1876	Second Empire	Design Value and Contextual Value	This is a 2.5 storey Second Empire Style building with a bell cast mansard roof and brick firewalls on either side. There are two semi-circular dormers with decorated hoods that are supported by white corbelled brackets and have white trim and lug sills. The roof eave projects to form an entablature which consists of molded frieze and dentil moulding supported by double brackets at each end - all painted white. There are 3 rectangular window openings each with a slightly curved top, plain white trim, large white keystone, and white moulded lug sill.	2.5	Historic Yonge Street

## Schedule of Contributing Properties

Address	Constructed	Architectural Character	Contribution to the District	Built Form	Stores	Character Area
Yonge 587	1906	Georgian	Design and Contextual Value	This is a 3 storey red brick building in a commercial style with Georgian simplicity. The parapet is plain red brick with a banding course above the third storey windows. The window openings on the third story all have flat arches with tapered brick voussoirs and prominent keystones. Each window on the third and second storey has a plain lug sill. On the second storey the windows have a plain stone lintel. There is a chimney on the southern wall of the building.	3	Historic Yonge Street
Yonge 588	1871	Second Empire	Design Value and Contextual Value	This 2.5 storey red brick building is designed in a "high" Second Empire style with extensive features and decorative brickwork. The mansard is surmounted by a moulded cornice and framed on the left by a decorative firewall. The dormer has a jerkin head style roof supported on brackets between a pair of windows with pilaster side frames on a continuous sill. The entablature includes decorative brackets supporting the cornice with dentils between.	2.5	Historic Yonge Street
Yonge 590	1888	Italianate	Design Value and Contextual Value	This 3 storey building is designed with predominantly Italianate features, and is one unit of a four unit attached brick building. Each unit is separated by a vertical pilaster with a large bracket at the sign band, a small "capital" at the third floor and again at the base of the entablature, finally terminating in a larger moulded capital at the upper cornice. A substantial sign band/cornice separates the ground floor shops from the upper two stories and with the principal pilasters frame the storefront. Each window has a rectangular lower and arched transom window and stone banding connects to this to form a continuous band. Window sills are also continuous forming a band. Within the spandrel between 2nd and 3rd floors there is a counter-relief decorative panel.	3	Historic Yonge Street

## Schedule of Contributing Properties

Address	Constructed	Architectural Character	Contribution to the District	Built Form	Storeys	Character Area
Yonge 592	1888	Italianate	Design Value and Contextual Value	This 3 storey building is designed with predominantly Italianate features, and is one unit of a four unit attached brick building. Each unit is separated by a vertical pilaster with a large bracket at the sign band, a small "capital" at the third floor and again at the base of the entablature, finally terminating in a larger moulded capital at the upper cornice. A substantial sign band/cornice separates the ground floor shops from the upper two stories and with the principal pilasters frame the storefront. Each window has a rectangular lower and arched transom window and stone banding connects to this to form a continuous band. Window sills are also continuous forming a band. Within the spandrel between 2nd and 3rd floors there is a counter-relief decorative panel.	3	Historic Yonge Street
Yonge 594	1888	Italianate	Design Value and Contextual Value	This 3 storey building is designed with predominantly Italianate features, and is one unit of a four unit attached brick building. Each unit is separated by a vertical pilaster with a large bracket at the sign band, a small "capital" at the third floor and again at the base of the entablature, finally terminating in a larger moulded capital at the upper cornice. A substantial sign band/cornice separates the ground floor shops from the upper two stories and with the principal pilasters frame the storefront. Each window has a rectangular lower and arched transom window and stone banding connects to this to form a continuous band. Window sills are also continuous forming a band. Within the spandrel between 2nd and 3rd floors there is a counter-relief decorative panel. This unit has been painted.	3	Historic Yonge Street

## Schedule of Contributing Properties

Address	Constructed	Architectural Character	Contribution to the District	Built Form	Storeys	Character Area
Yonge 596	1888	Italianate	Design Value and Contextual Value	This 3 storey building is designed with predominantly Italianate features, and is one unit of a four unit attached brick building. Each unit is separated by a vertical pilaster with a large bracket at the sign band a small "capital" at the third floor and again at the base of the entablature, finally terminating in a larger moulded capital at the upper cornice. A substantial sign band/cornice separates the ground floor shops from the upper two stories and with the principal pilasters frame the storefront. Each window has a rectangular lower and arched transom window and stone banding connects to this to form a continuous band. Window sills are also continuous forming a band. Within the spandrel between 2nd and 3rd floors there is a counter-relief decorative panel.	3	Historic Yonge Street
Yonge 598 600	1886	Italianate	Design Value and Contextual Value	This is a 3 storey building designed with predominantly Italianate style features of the era. It is 3 storeys in height and part of a row of similarly designed buildings. in each building. Each building is separated by a vertical pilaster with a large bracket at the sign band/cornice rising to the building entablature, finally terminating in a larger corbelled brick bracket at the upper cornice. Between principal pilasters are 3 smaller pilasters which, unusually, corbel out of the wall near the head of the second floor windows with 2 saw tooth panels at the third floor spandrel between pilasters. A brick entablature with string courses, a saw tooth band and corbelled brick detailing support a shallow projecting cornice at the roofline. The building sits on a brick foundation.	3	Historic Yonge Street
Yonge 601 - 613 Gloucester 2, 6	1888	Renaissance Revival	Design and Contextual Value	This is a 4 storey red brick building designed in a high Renaissance Revival Style. Its features and architectural details include stone dressings, brick and stone voussoirs, stone keystones, lintels and column capitals. There are 7 structural bays along Yonge St. bookended by 5 storey towers. A paneled parapet links the two towers and is separated by a projecting cornice from the wall below. The window transoms have stained glass panels and spandrels are a mix of stone lintels and cast iron lintels.	4	Historic Yonge Street

## Schedule of Contributing Properties

Address	Constructed	Architectural Character	Contribution to the District	Built Form	Storeys	Character Area
Yonge 602 604	1886	Italianate	Design Value and Contextual Value	This is a 3 storey building designed with predominantly Italianate style features of the era. It is 3 storeys in height and part of a row of similarly designed buildings. in each building. Each building is separated by a vertical pilaster with a large bracket at the sign band/cornice rising to the building entablature, finally terminating in a larger corbelled brick bracket at the upper cornice. Between principal pilasters are 3 smaller pilasters which, unusually, corbel out of the wall near the head of the second floor windows with 2 saw tooth panels at the third floor spandrel between pilasters. A brick entablature with string courses, a saw tooth band and corbelled brick detailing support a shallow projecting cornice at the roofline. The building sits on a brick foundation.	3	Historic Yonge Street
Yonge 606 608	1886	Italianate	Design Value and Contextual Value	This is a 3 storey building designed with predominantly Italianate style features of the era. It is 3 storeys in height and part of a row of similarly designed buildings. in each building. Each building is separated by a vertical pilaster with a large bracket at the sign band/cornice rising to the building entablature, finally terminating in a larger corbelled brick bracket at the upper cornice. Between principal pilasters are 3 smaller pilasters which, unusually, corbel out of the wall near the head of the second floor windows with 2 saw tooth panels at the third floor spandrel between pilasters. A brick entablature with string courses, a saw tooth band and corbelled brick detailing support a shallow projecting cornice at the roofline. The building sits on a brick foundation.	3	Historic Yonge Street



## Schedule of Contributing Properties

Address	Constructed	Architectural Character	Contribution to the District	Built Form	Storeys	Character Area
Yonge 610 612	1886	Italianate	Design Value and Contextual Value	This is a 3 storey building designed with predominantly Italianate style features of the era. It is 3 storeys in height and part of a row of similarly designed buildings. Each building is separated by a vertical pilaster with a large bracket at the sign band/cornice rising to the building entablature, finally terminating in a larger corbelled brick bracket at the upper cornice. Between principal pilasters are 3 smaller pilasters which, unusually, corbel out of the wall near the head of the second floor windows with 2 saw tooth panels at the third floor spandrel between pilasters. A brick entablature with string courses, a saw tooth band and corbelled brick detailing support a shallow projecting cornice at the roofline. The building sits on a brick foundation.	3	Historic Yonge Street
Yonge 614	1885	Italianate	Design Value and Contextual Value	This is a 2.5 storey commercial structure with architectural features predominantly of the Italianate Style of the era. The upper storey has segmental-arched window openings, with brick hood moulds with keystones and stone sills and elaborate brick detailing inspired by the Italianate style. These openings have brick hood moulds with keystones and stone sills. There is detailing beneath the eaves with brick panels and brackets. The gable roof has a gabled dormer. The building sits on a stone foundation.	2.5	Historic Yonge Street
Yonge 615	1915	Edwardian Classicism	Design and Contextual Value	This building was designed in an Edwardian Classicism style. It is distinguished by its classical organization and detailing, particularly the stone embellishments and date stone in the upper floors. Some of the building's features include: coping along the flat roofline; the tripartite organization of the facade, the orange-brown brick and stone piers, the cornices with brackets, and the classical detailing that includes the stone ornaments on the brick piers near the roofline.	6	Historic Yonge Street
Yonge 616	1885	Edwardian	Contextual Value	This building originally would have resembled adjacent Italianate buildings with pitched roofs but was retro-fitted with Edwardian-style features. It is clad in brick. Windows are above a continuous stone sill forming a band. The second floor has an oversized rectangular glass window which is divided into 8 lights and with a continuous stone sill. It has a moulded entablature at its roof line.	4	Historic Yonge Street

## Schedule of Contributing Properties

Address	Constructed	Architectural Character	Contribution to the District	Built Form	Storeys	Character Area
Yonge 618	1876	Renaissance Revival	Design Value and Contextual Value	The is a 2.5 storey building designed with Georgian simplicity and Renaissance Revival features. It is clad in red brick. Upper storey windows are arched with polychromatic brickwork, drip lintels and pronounced keystones. The gable roof has a small round arched dormer on the east slope. Stone lug sill rest on brick brackets. Corners feature buff quoining.	2.5	Historic Yonge Street
Yonge 619 623	1923	Early Modern (Chicago School)	Design and Contextual Value	This is a 2 storey simple brick commercial building. It has a flat roof it is of plain brick with no ornamentation and has been painted. Window openings have a plain heads with no accentuating brickwork. The sill is a plain slip sill. A part bay at the south end contains a doorway to the upper floor.	2	Historic Yonge Street
Yonge 620 622	1878	Second Empire	Contextual Value	This is a 2.5 storey second empire stucco on brick building. It is part of a row of second empire buildings. It has bell shaped dormers with carved wood openings, and paneling on its roof.	2.5	Historic Yonge Street
Yonge 624	1878	Second Empire	Design and Contextual Value	This is a 2-1/2 storey, stucco on brick, Second Empire Style Building. This building is part of a row of commercial structures (620-632) constructed in pairs, separated by fire wall parapets and shallow pilasters, in the same style. A small cornice "cap" tops the mansard. At the mansard there is a single dormer with a wood surround including a projecting arched hood moulding with carved keystone-finial and brackets. The mansard has a projecting eave supported on brackets; between brackets is a raised brick panel and banding course.	2.5	Historic Yonge Street
Yonge 626	1878	Second Empire	Design and Contextual Value	This is a 2-1/2 storey, stucco on brick, Second Empire Style Building. This building is part of a row of commercial structures (620-632) constructed in pairs, separated by fire wall parapets and shallow pilasters, in the same style. A small cornice "cap" tops the mansard. At the mansard there is a single dormer with a wood surround including a projecting arched hood moulding with carved keystone-finial and brackets. The mansard has a projecting eave supported on brackets; between brackets is a raised brick panel and banding course.	2.5	Historic Yonge Street

## Schedule of Contributing Properties

Address	Constructed	Architectural Character	Contribution to the District	Built Form	Storeys	Character Area
Yonge 627 629	1921	Edwardian Classical	Design and Contextual Value	This building is designed in an Edwardian style and related to the adjoining corner building. It is clad in brick that has been painted. There is a stepped parapet with central stepped architrave. atop a banding course forming a simplified entablature. The facade is organized into 3 bays by projecting pilasters. The end pilasters rise to the roof, the middle to the entablature and are capped by corbelled brick forming a capital expression.	3	Historic Yonge Street
Yonge 628	1878	Second Empire	Design and Contextual Value	This is a 2-1/2 storey, stucco on brick, Second Empire Style Building. This building is part of a row of commercial structures (620-632) constructed in pairs, separated by fire wall parapets and shallow pilasters, in the same style. A small cornice "cap" tops the mansard. At the mansard there is a single dormer with a wood surround including a projecting arched hood moulding with carved keystone-finial and brackets. The mansard has a projecting eave supported on brackets; between brackets is a raised brick panel and banding course.	2.5	Historic Yonge Street
Yonge 630	1878	Second Empire	Design and Contextual Value	This is a 2-1/2 storey, stucco on brick, Second Empire Style Building. This building is part of a row of commercial structures (620-632) constructed in pairs, separated by fire wall parapets and shallow pilasters, in the same style. A small cornice "cap" tops the mansard. At the mansard there is a single dormer with a wood surround including a projecting arched hood moulding with carved keystone-finial and brackets. The mansard has a projecting eave supported on brackets; between brackets is a raised brick panel and banding course.	2.5	Historic Yonge Street
Yonge 631 - 637 Isabella 3 5 7	1905	Edwardian Classicism	Design and Contextual Value	This is a 3 storey building designed in a simple Edwardian style, and related to the adjacent building at 627-629 Yonge. The façade is divided vertically into 3 parts. A parapet defined by a banding course at the roof line, a continuous band at the third floor window sills, and a tile-clad base at the ground floor with display windows and entrances.	3	Historic Yonge Street

## Schedule of Contributing Properties

Address	Constructed	Architectural Character	Contribution to the District	Built Form	Storeys	Character Area
Yonge 632	1878	Second Empire	Design and Contextual Value	This is a 2-1/2 storey, stucco on brick, Second Empire Style Building. This building is part of a row of commercial structures (620-632) constructed in pairs, separated by fire wall parapets and shallow pilasters, in the same style. A small cornice "cap" tops the mansard. At the mansard there is a single dormer with a wood surround including a projecting arched hood moulding with carved keystone-finial and brackets. The mansard has a projecting eave supported on brackets; between brackets is a raised brick panel and banding course.	2.5	Historic Yonge Street
Yonge 634	1865	Georgian	Design and Contextual Value	This is a 2-1/2 storey building in a late Georgian Style. It is part of a row of building separated into 3 pairs of two units for a total of 6 units by parapet firewalls. It has a low sloped roof with a hipped roof dormer clad in horizontal siding and a square window opening. The roof includes a projecting eave which is supported by a corbelled, brick, dentilated frieze at the top of the brick wall. At the second floor there are two flat arch window openings and plain lug sills.	2.5	Historic Yonge Street
Yonge 636	1865	Georgian	Design and Contextual Value	This is a 2-1/2 storey building in a late Georgian Style. It is part of a row of building separated into 3 pairs of two units for a total of 6 units by parapet firewalls. It has a low sloped roof with a hipped roof dormer clad in horizontal siding and a square window opening. The roof includes a projecting eave which is supported by a corbelled, brick, dentilated frieze at the top of the brick wall. At the second floor there are two flat arch window openings and plain lug sills.	2.5	Historic Yonge Street
Yonge 638	1865	Georgian	Design and Contextual Value	This is a 2-1/2 storey building in a late Georgian Style. It is part of a row of building separated into 3 pairs of two units for a total of 6 units by parapet firewalls. It has a low sloped roof with a hipped roof dormer clad in horizontal siding and a square window opening. The roof includes a projecting eave which is supported by a corbelled, brick, dentilated frieze at the top of the brick wall. At the second floor there are two flat arch window openings and plain lug sills.	2.5	Historic Yonge Street
Yonge 639	1879	Second Empire	Design Value and Contextual Value	This property contains a 2.5 storey mixed-use building designed in a second empire style, with: a mansard roof; bell shaped dormers of carved wood; a decorated soffit with eaves, and vertically oriented semi-circular windows.	2.5	Historic Yonge Street

## Schedule of Contributing Properties

Address	Constructed	Architectural Character	Contribution to the District	Built Form	Storeys	Character Area
Yonge 640	1865	Georgian	Design and Contextual Value	This is a 2-1/2 storey building in a late Georgian Style. It is part of a row of building separated into 3 pairs of two units for a total of 6 units by parapet firewalls. It has a low sloped roof with a hipped roof dormer clad in horizontal siding and a square window opening. The roof includes a projecting eave which is supported by a corbelled, brick, dentilated frieze at the top of the brick wall. At the second floor there are two flat arch window openings and plain lug sills.	2.5	Historic Yonge Street
Yonge 641 643	1951	Mid Century Modern	Design Value and Contextual Value	This is a 4 storey building designed in a mid-century modern architectural style and clad in brick. It has vertically oriented windows clustered in bays and framed with continuous lintels and sills.	4	Historic Yonge Street
Yonge 642 644	1865	Georgian	Design and Contextual Value	This is a 2-1/2 storey building in a late Georgian Style. It is part of a row of building separated into 3 pairs of two units for a total of 6 units by parapet firewalls. It has a low sloped roof with a hipped roof dormer clad in horizontal siding and a square window opening. The roof includes a projecting eave which is supported by a corbelled, brick, dentilated frieze at the top of the brick wall. At the second floor there are two flat arch window openings and plain lug sills.	2.5	Historic Yonge Street
Yonge 645	1890	Italianate	Design Value and Contextual Value	This is a two storey building constructed in an Italianate style with extensive brick detailing, including continuous lintels and sills that frame vertically oriented windows.	2	Historic Yonge Street
Yonge 646 648 650 650A	1873	Georgian	Design and Contextual Value	This 2-1/2 storey building is designed in a Georgian Style building but clad with stucco on brick. It is a pair of similar buildings separated by a parapet firewall. At the third floor there is a sloping roof with two pedimented dormers per unit (4 in total). They each contain rectangular window openings with replacement windows with 8/2 grilles and might have horizontal slider. At the second storey there are 4 windows per unit (total 8). Large eared moulded frames surround the openings.	2.5	Historic Yonge Street
Yonge 647 649	1878	Italianate Commercial	Design Value and Contextual Value	This property contains a 3 storey mixed-use building designed in a Romanesque style. It includes decorative brick work framing vertically oriented windows, such as lintels, sills, and corbelling.	3	Historic Yonge Street

## Schedule of Contributing Properties

Address	Constructed	Architectural Character	Contribution to the District	Built Form	Storeys	Character Area
Yonge 651 653	1912	Over-clad	Contextual Value	This property contains a 2.5 storey building that appears to have been designed in a second empire style. It has been over-clad with a metal lattice that obscures the building's features.	2.5	Historic Yonge Street
Yonge 654 656	1873	Georgian	Design and Contextual Value	This 2.5 storey building is designed in a simple Georgian Style. The roof slopes back and includes 2 small dormers with gable ended roofs that have been covered. The wall is red brick with buff brick drip hoods, over 4 second floor windows, brick sills and a banding course above the storefront. Storefronts, 1 per unit, are book matched with glass in metal frame display windows on metal panel curb walls separated by central recessed, paired, store entrances and a third centre door to upper floors.	2.5	Historic Yonge Street
Yonge 655	1887	Italianate	Design Value and Contextual Value	This building is designed in an Italianate style, and clad in brick with carved wood and stone detailing. It has extensive decorative brickwork including corbelling, carved entablatures and brackets, and continuous lintels. It is a bay of a larger building, demarcated by a pilaster. The brick on this building has been painted.	3	Historic Yonge Street
Yonge 657	1887	Italianate	Design Value and Contextual Value	This building is designed in an Italianate style, and clad in brick with carved wood and stone detailing. It has extensive decorative brickwork including corbelling, carved entablatures and brackets, and continuous lintels. It is a bay of a larger building, demarcated by a pilaster.	3	Historic Yonge Street
Yonge 658	1873	Georgian	Design and Contextual Value	This is a 2-1/2 storey, painted brick building in a simplified Georgian Style. It has a sloping roof with a pedimented dormer. On the second floor there are two segmental arched window openings with raised brick drip hood mouldings. There is a brick lug sill below. On this building the upper floor has been painted, thus obscuring the dichromatic brickwork seen at 656 and 654.	2.5	Historic Yonge Street
Yonge 659	1887	Italianate	Design Value and Contextual Value	This building is designed in an Italianate style, and clad in brick with carved wood and stone detailing. It has extensive decorative brickwork including corbelling, carved entablatures and brackets, and continuous lintels. It is a bay of a larger building, demarcated by a pilaster.	3	Historic Yonge Street
Yonge 660	1876	Georgian	Design and Contextual Value	This is a two storey building designed in a simple Georgian style with a gable roof. It is clad in brick that has been painted and includes brick voussoirs and lug sills.	2	Historic Yonge Street

## Schedule of Contributing Properties

Address	Constructed	Architectural Character	Contribution to the District	Built Form	Storeys	Character Area
Yonge 662	1876	Over-clad	Design and Contextual Value	This is a two storey building that has been over-clad, obscuring its features. Some of the building's brick façade is visible behind its over-cladding.	2	Historic Yonge Street
Yonge 664	1883	Second Empire	Design and Contextual Value	This is a 2-1/2 storey brick building built in the Second Empire style. It is part of a row of units divided by parapet firewalls at the roof and projecting brick pilasters at the wall into 5 sections of two commercial units with residential above. Its overall size and period detailing give it prominence on Yonge St. It is a fine and highly detailed version of the Second Empire Style. The roof is gambrel with projecting cornice clad in tile or red slate shingles. Firewalls include a bracket form at the base and top.	3	Historic Yonge Street
Yonge 665	1949	Modern	Design Value and Contextual Value	This property contains a portion of a commercial building constructed in a modern architectural style. It has brick cladding, a flat roof and windows that form an arch over its entryway.	2	Historic Yonge Street
Yonge 666	1883	Second Empire	Design and Contextual Value	This is a 2-1/2 storey brick building built in the Second Empire style. It is part of a row of units divided by parapet firewalls at the roof and projecting brick pilasters at the wall into 5 sections of two commercial units with residential above. Its overall size and period detailing give it prominence on Yonge St. It is a fine and highly detailed version of the Second Empire Style. The roof is gambrel with projecting cornice clad in tile or red slate shingles. Firewalls include a bracket form at the base and top.	3	Historic Yonge Street
Yonge 668	1883	Second Empire	Design and Contextual Value	This is a 2-1/2 storey brick building built in the Second Empire style. It is part of a row of units divided by parapet firewalls at the roof and projecting brick pilasters at the wall into 5 sections of two commercial units with residential above. Its overall size and period detailing give it prominence on Yonge St. It is a fine and highly detailed version of the Second Empire Style. The roof is gambrel with projecting cornice clad in tile or red slate shingles. Firewalls include a bracket form at the base and top.	3	Historic Yonge Street

## Schedule of Contributing Properties

Address	Constructed	Architectural Character	Contribution to the District	Built Form	Storeys	Character Area
Yonge 670	1883	Second Empire	Design and Contextual Value	This is a 2-1/2 storey brick building built in the Second Empire style. It is part of a row of units divided by parapet firewalls at the roof and projecting brick pilasters at the wall into 5 sections of two commercial units with residential above. Its overall size and period detailing give it prominence on Yonge St. It is a fine and highly detailed version of the Second Empire Style. The roof is gambrel with projecting cornice clad in tile or red slate shingles. Firewalls include a bracket form at the base and top.	3	Historic Yonge Street
Yonge 672	1883	Second Empire	Design and Contextual Value	This is a 2-1/2 storey brick building built in the Second Empire style. It is part of a row of units divided by parapet firewalls at the roof and projecting brick pilasters at the wall into 5 sections of two commercial units with residential above. Its overall size and period detailing give it prominence on Yonge St. It is a fine and highly detailed version of the Second Empire Style. The roof is gambrel with projecting cornice clad in tile or red slate shingles. Firewalls include a bracket form at the base and top.	3	Historic Yonge Street
Yonge 674	1883	Second Empire	Design and Contextual Value	This is a 2-1/2 storey brick building built in the Second Empire style. It is part of a row of units divided by parapet firewalls at the roof and projecting brick pilasters at the wall into 5 sections of two commercial units with residential above. Its overall size and period detailing give it prominence on Yonge St. It is a fine and highly detailed version of the Second Empire Style. The roof is gambrel with projecting cornice clad in tile or red slate shingles. Firewalls include a bracket form at the base and top.	3	Historic Yonge Street
Yonge 675 681 Charles East 4 6	1905	Renaissance Revival	Design Value and Contextual Value	This is a 3.5 storey building clad in stone and designed in a Renaissance Revival style. It includes a vertical addition that appears just above its roof line.	3.5	Historic Yonge Street
Yonge 676	1883	Second Empire	Design and Contextual Value	This is a 2-1/2 storey brick building built in the Second Empire style. It is part of a row of units divided by parapet firewalls at the roof and projecting brick pilasters at the wall into 5 sections of two commercial units with residential above. Its overall size and period detailing give it prominence on Yonge St. It is a fine and highly detailed version of the Second Empire Style. The roof is gambrel with projecting cornice clad in tile or red slate shingles. Firewalls include a bracket form at the base and top.	3	Historic Yonge Street



## Schedule of Contributing Properties

Address	Constructed	Architectural Character	Contribution to the District	Built Form	Storeys	Character Area
Yonge 678	1883	Second Empire	Design and Contextual Value	This is a 2-1/2 storey brick building built in the Second Empire style. It is part of a row of units divided by parapet firewalls at the roof and projecting brick pilasters at the wall into 5 sections of two commercial units with residential above. Its overall size and period detailing give it prominence on Yonge St. It is a fine and highly detailed version of the Second Empire Style. The roof is gambrel with projecting cornice clad in tile or red slate shingles. Firewalls include a bracket form at the base and top.	3	Historic Yonge Street
Yonge 680 682	1883	Second Empire	Design and Contextual Value	This is a 2-1/2 storey brick building built in the Second Empire style. It is part of a row of units divided by parapet firewalls at the roof and projecting brick pilasters at the wall into 5 sections of two commercial units with residential above. Its overall size and period detailing give it prominence on Yonge St. It is a fine and highly detailed version of the Second Empire Style. The roof is gambrel with projecting cornice clad in tile or red slate shingles. Firewalls include a bracket form at the base and top.	3	Historic Yonge Street
Yonge 685	1869	Edwardian Commercial	Contextual Value	This is a two storey mixed use building with two entablatures and painted brick cladding.	2	Historic Yonge Street
Yonge 686 686A 688 690	1873	Second Empire	Design and Contextual Value	This is a 2-1/2 storey, 3 unit, painted brick building in a Second Empire Style. There is a mansard roof with three dormers, 1 per unit. A projecting cornice caps the mansard which is framed by projecting end firewalls and it ends at a projecting gutter-cornice at the second floor the cornice is part of a simple entablature with plain frieze and corbelled and dentilated architrave. There are 6 evenly spaced window openings, 2 per unit, each with segmental arched heads, brick voussoirs, keystones and plain lug sills.	2.5	Historic Yonge Street
Yonge 689	1869	Over-clad	Contextual Value	This is a two storey property that has been over-clad, obscuring its architectural features.	2	Historic Yonge Street
Yonge 691	1869	Over-clad	Contextual Value	This is a two storey property that has been over-clad, obscuring its architectural features.	2	Historic Yonge Street
Yonge 692	1909	Over-clad (Edwardian classicalism)	Contextual Value	This building has been over-clad with a metal lattice that obscures its features. Close to the building its features can be seen and are generally intact and a mirror image of 694 Yonge Street.	2	Historic Yonge Street

## Schedule of Contributing Properties

Address	Constructed	Architectural Character	Contribution to the District	Built Form	Storeys	Character Area
Yonge 694	1909	Edwardian Classicalism	Design and Contextual Value	This is a 2 storey building in the Edwardian Classical style. The second floor has 3 grouped window openings. Window openings have a shared continuous stone lintel with a carved stone medallion above each window. A brick entablature includes a plain architrave, corbelled plain brick frieze and a further corbelled and dentilated brick cornice. Above the cornice is a plain brick parapet with a central, stepped up and sloping, central gable.	2	Historic Yonge Street
Yonge 695	1869	Over-clad	Contextual Value	This is a two storey property that has been over-clad, obscuring its architectural features.	2	Historic Yonge Street
Yonge 696 698 700	1954	International	Design and Contextual Value	This building is designed in the International Style, with a clean facade and balanced proportions. Distinguishing features of this building are its continuous ribbon windows. They create a continuous band of windows from the west facade to the north facade, to the east facade, and extend partially into the southern facade as well. Buff brick is used on the spandrels between the windows. The main floor is clad with green marble, which frames the entrances. That same marble covers the main floor eastern and northern facade.	8	Historic Yonge Street
Yonge 699 701 703	1889	Over-clad	Contextual Value	This is a three storey building that has been over-clad, obscuring its features	3	Historic Yonge Street
Yonge 707 705 Hayden 7 9	1939	Over-clad	Contextual Value	This is a three storey building that has been over-clad, obscuring its features.	3	Historic Yonge Street
Yonge 710	1909	Edwardian Commercial	Design Value and Contextual Value	This is a two storey building designed in an Italianate style with decorative brickwork at the cornice and carved stone medallions above each window. It is part of a row of similarly designed buildings.	2	Historic Yonge Street
Yonge 712	1909	Edwardian Commercial	Design Value and Contextual Value	This is a two storey building designed in an Italianate style with decorative brickwork at the cornice and carved stone medallions above each window. It is part of a row of similarly designed buildings.	2	Historic Yonge Street
Yonge 714	1909	Edwardian Commercial	Design Value and Contextual Value	This is a two storey building designed in an Italianate style with decorative brickwork at the cornice and carved stone medallions above each window. It is part of a row of similarly designed buildings.	2	Historic Yonge Street
Yonge 716	1909	Edwardian Commercial	Design Value and Contextual Value	This is a two storey building designed in an Italianate style with decorative brickwork at the cornice and carved stone medallions above each window. It is part of a row of similarly designed buildings.	2	Historic Yonge Street

## Schedule of Contributing Properties

Address	Constructed	Architectural Character	Contribution to the District	Built Form	Storeys	Character Area
Yonge 718	1909	Over-clad	Contextual Value	This is a two storey building that has been overclad with signage. It is likely constructed in a similar architectural style to adjacent Italianate commercial buildings.	2	Historic Yonge Street
Yonge 728	1889	Richardsonian Romanesque	Design Value and Contextual Value	This is a three storey building designed in a Richardsonian Romanesque style. It features extensive decorative brickwork including: carved panels; arched voussoirs and continuous sills with corbelling.	3	Historic Yonge Street
Yonge 750	1903	Renaissance Revival	Design Value and Contextual Value	This is a three storey building designed in a Renaissance Revival style, it is clad in brick and has a decorative cornice. Its brick has been painted, and its building features are partially obscured by signage.	3	Historic Yonge Street
Yonge 752 754	1890	Edwardian Classical	Design Value and Contextual Value	This is a three storey building designed in an Edwardian classical style. It includes two moulded entablatures demarcating transitions between floors and to the roof line, as well as decorative urns at the roof line.	3	Historic Yonge Street
Yonge 758	1909	Edwardian	Design Value and Contextual Value	This is a three storey building designed in an Edwardian style, it is clad in brick and features decorative brickwork including a moulded cornice and fenestration details.	3	Historic Yonge Street
Yonge 764	1918	Art Deco	Design Value and Contextual Value	This building is a two storey building designed in an art deco style, with a decorative entablature and stone carvings. Originally this was constructed as a theatre, and the gap in the entablature was for a large vertical sign advertising shows.	2	Historic Yonge Street
Yonge 768	1909	Italianate	Design Value and Contextual Value	This is a two storey building constructed in an Italianate style with a decorative cornice.	2	Historic Yonge Street
Yonge 774 776	1885	Italianate	Design Value and Contextual Value	This property contains a 3 storey building designed in an Italianate style, it features extensive decorative polychromatic brickwork, and carved stone or wood features.	3	Historic Yonge Street
Yonge 778	1909	Modern	Design Value and Contextual Value	This is a two storey building constructed in a early modern style, with a continuous window bay, and a plain stone façade. Commercial signage has obscured parts of the building's façade.	2	Historic Yonge Street

# C

## APPENDIX C: SCHEDULE OF NON- CONTRIBUTING PROPERTIES

## Schedule of Non-Contributing Properties

Address	Constructed	Storeys	Character Area
Charles east 3	1875	2	Historic Yonge Street
Charles East 8	n/a	0	Historic Yonge Street
Dundonald 2A 2B 2C 2D 2E	1975	1	Historic Yonge Street
Grenville 9 15	n/a	n/a	Historic Yonge Street
Irwin 15	1876	3	St. Nicholas Village
Irwin 23	1981	3.5	St. Nicholas Village
Irwin 25	1981	3.5	St. Nicholas Village
Irwin 27	1981	3.5	St. Nicholas Village
Irwin 29	1981	3.5	St. Nicholas Village
Isabella 14	1903	2.5	Residential Pockets
Isabella 16	1903	2	Residential Pockets
Isabella 7 9	1947	2	Historic Yonge Street
St Nicholas 75 (65 67 69 71 73)	n/a	n/a	St. Nicholas Village
Wellesley 1 3	1980	2	Historic Yonge Street
Wellesley 6 6A 8	1884	2	Residential Pockets
Wellesley East 8 Yonge 561 563	1997	11	Historic Yonge Street
Yonge 451 - 471	1957	18	College/Carlton
Yonge 454 - 468	1951	2	College/Carlton
Yonge 470	1959	1	Historic Yonge Street
Yonge 475	1956	16 & 9	College/Carlton
Yonge 478	1910	1	Historic Yonge Street
Yonge 492	1949	3	Historic Yonge Street
Yonge 500 502	2012	3	Historic Yonge Street
Yonge 501 - 517	1956	2	Historic Yonge Street
Yonge 510 512	1969	1	Historic Yonge Street
Yonge 518 520	1903	3	Historic Yonge Street
Yonge 519 - 523	1952	1	Historic Yonge Street
Yonge 543 545	1978	4	Historic Yonge Street
Yonge 555	1968	9	Historic Yonge Street
Yonge 558	1895	2	Historic Yonge Street
Yonge 589 591 593 595	1904	3	Historic Yonge Street
Yonge 597 599	1976	2	Historic Yonge Street
Yonge 661 663	1957	5	Historic Yonge Street
Yonge 673	1990	3	Historic Yonge Street
Yonge 684	1929	2	Historic Yonge Street
Yonge 687	1869	2	Historic Yonge Street
Yonge 730	1969	16	Historic Yonge Street
Yonge 760 762	1880	2	Historic Yonge Street
Yonge 770	1939	1	Historic Yonge Street
Yonge 780 782	1914	3	Historic Yonge Street
Yonge 784	1884	3	Historic Yonge Street
Yonge 778	1909	2	Historic Yonge Street

*Demolished*

*Demolished*

*Demolished*